



# HOME HARDWARE TECHNOLOGY PRODUCTS

---

## PRODUCT















Price List W.E.F.DT-01/04/2026

















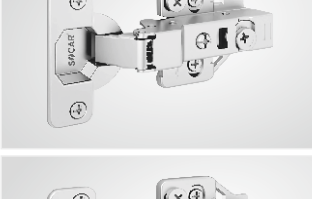

# 07

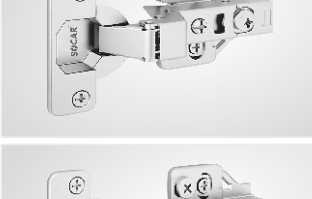



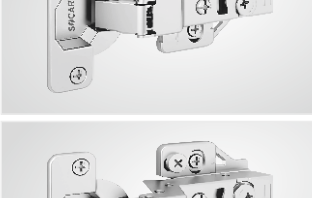







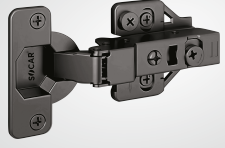

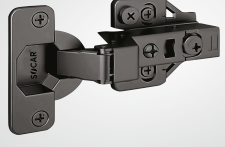



# CONTENTS

















## / CONTENTS













<b>AUTO HINGES</b>	<b>01-05</b>
<b>DRAWER SLIDES</b>	<b>06</b>
<b>FURNITURE FEETINGS</b>	<b>07-08</b>
<b>CABINET FITTINGS</b>	<b>09</b>
<b>KITCHEN &amp; WARDROBE DRAWERS</b>	<b>10-28</b>
• SMART BOX	
• GLASS BOX	
• M-TEK BOX	
<b>KITCHEN ACCESSORIES</b>	<b>29-31</b>
<b>SLIDING FITTINGS</b>	<b>32-39</b>
<b>SLIDING FOLDING SERIES</b>	<b>40-42</b>
• WOODEN DOOR SLIDING FOLDING	
• GLASS DOOR SLIDING FOLDING	
<b>DOOR CLOSER &amp; FLOOR SPRING</b>	<b>43-44</b>
<b>PATCH FITTINGS</b>	<b>45</b>
<b>DOOR HARDWARE</b>	<b>46-48</b>
• DOOR HANDLES	
• DOOR LOCKS CYLINDERS	
• DOOR STREIGHTNER	
• DOOR DROP DOWN SEAL	

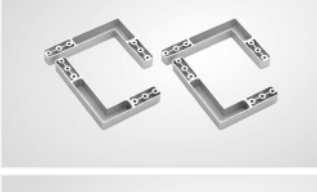

SR.	IMAGE	ITEM CODE	DESCRIPTION	PER	
1		SAH SL 101E	Auto Hinges Slide On Full Overlay	SET	
2		SAH SL 102E	Auto Hinges Slide On Half Overlay	SET	
3		SAH SL 103E	Auto Hinges Slide On Inset Overlay	SET	
4		SAH CL 111E	Auto Hinges 2D, Soft Close & Clip On Full Overlay 	SET	
5		SAH CL 112E	Auto Hinges 2D, Soft Close & Clip On Half Overlay 	SET	
6		SAH CL113E	Auto Hinges 2D, Soft Close & Clip On Inset Application 	SET	
7		SAH CL 111	Auto Hinges Pro 2D, Soft Close & Clip On Full Overlay 	SET	
8		SAH CL 112	Auto Hinges Pro 2D, Soft Close & Clip On Half Overlay 	SET	
9		SAH CL 113	Auto Hinges Pro 2D, Soft Close & Clip On Inset Application 	SET	

SR.	IMAGE	ITEM CODE	DESCRIPTION	PER
10		SAH CL 111 BLACK	Auto Hinges 2D, Black Soft Close & Clip On Full Overlay 	SET
11		SAH CL 112 BLACK	Auto Hinges 2D, Black Soft Close & Clip On Half Overlay 	SET
12		SAH CL 113 BLACK	Auto Hinges 2D, Black Soft Close & Clip On Inset Application 	SET
13		SAH CL 111 3D	Auto Hinges Pro 3D Full Overlay, Clip On For 22mm Door 	SET
14		SAH CL 112 3D	Auto Hinges Pro 3D Half Overlay, Clip On For 22mm Door 	SET
15		SAH CL 113 3D	Auto Hinges Pro 3D Inset Application, Clip On For 22mm Door 	SET
16		SAH CL 151 3D	Auto Hinges 3D Full Overlay, Clip On For 22mm Door 	SET
17		SAH CL 152 3D	Auto Hinges 3D Half Overlay, Clip On For 22mm Door 	SET
18		SAH CL 153 3D	Auto Hinges 3D Inset Application, Clip On For 22mm Door 	SET

SR.	IMAGE	ITEM CODE	DESCRIPTION	PER
19		SAH CL 161 3D BLACK	Auto Hinges 3D, Black Soft Close & Clip On Full Overlay 	SET
20		SAH CL 162 3D BLACK	Auto Hinges 3D, Black Soft Close & Clip On Half Overlay 	SET
21		SAH CL 163 3D BLACK	Auto Hinges 3D, Black Soft Close & Clip On Inset Application 	SET
22		SAH CL 201 3D	Auto Hinges For 16mm To 28mm Thick Door Full Overlay With 3D Adjustment 	SET
23		SAH CL 202 3D	Auto Hinges For 16mm To 28mm Thick Door Half Overlay With 3D Adjustment 	SET
24		SAH CL 203 3D	Auto Hinges For 16mm To 28mm Thick Door Inset Application With 3D Adjustment 	SET
25		SAH CL 121	Full Overlay Hinge (Clip On) Thick Door 20 to 40mm 	SET
26		SAH CL 122	Half Overlay Hinge (Clip On) Thick Door 20 to 40mm 	SET
27		SAH CL 123	Inset Overlay Hinge (Clip On) Thick Door 20 to 40mm 	SET

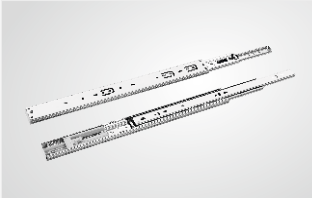

SR.	IMAGE	ITEM CODE	DESCRIPTION	PER
28		SAH CL 114 3D	Auto Hinges 165° Full Overlay 3D Adjust Clip On 	SET
29		SAH CL 117	Bi-Fold Hinge (Clip On) For 22mm Door	SET
30		SAH CL 124	Full Overlay 6mm Glass Hinge (Clip On) 	SET
31		SAH CL 125	Half Overlay 6mm Glass Hinge (Clip On) 	SET
32		SAH CL 126	Inset Overlay 6mm Glass Hinge (Clip On) 	SET
33		SPCA CL 130 3D BLACK	Aluminium Profile Hinge Full Overlay Black with 3D Plate 	SET
34		SPCA CL 131 3D BLACK	Aluminium Profile Hinge Half Overlay Black with 3D Plate 	SET
35		SPCA CL 132 3D BLACK	Aluminium Profile Hinge Inset Overlay Black with 3D Plate 	SET
36		SPCA CL 133 BLACK	Aluminium Profile Hinge FOR 22MM 165° Full Overlay Clip On Black 	SET

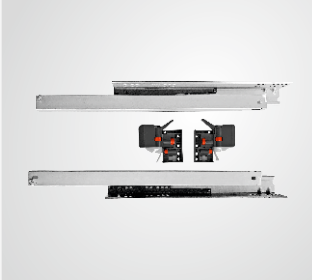
SR.	IMAGE	ITEM CODE	DESCRIPTION	PER
37		SCPH 001	Air Hinge With 20kg Weight Capacity Max Door Width 450mm 	SET
38		SCPH 002	Air Hinge With 30kg Weight Capacity Max Door Width 700mm 	SET
39		SCPH 003	270 Degree Aluminum Profile Hinges (Suitable For Sap 209, Sap 210) 	SET
40		SPCA 177	Angle Connector For SCPH 001	SET
41		SPCA 211	Angle Connector For SCPH 002	SET
42		SAH CL 301 BL	Full Overlay Heavy Duty Auto Hinges With Cover (50kg/set) 	SET
43		SAH CL 302 BL	Half Overlay Heavy Duty Auto Hinges With Cover (50kg/set) 	SET
44		SAH CL 303 BL	Inset Overlay Heavy Duty Auto Hinges With Cover (50kg/set) 	SET

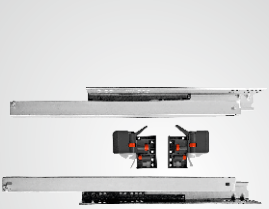
SR.	IMAGE	DESCRIPTION	ITEM CODE
1		Full Extension Ball Bearing Slide Finish - Zinc Plated / Black Powder Coated Weight Capacity - 45 kgs	SE SLIDE 008 BK / ZK
			SE SLIDE 010 BK / ZK
			SE SLIDE 012 BK / ZK
			SE SLIDE 014 BK / ZK
			SE SLIDE 016 BK / ZK
			SE SLIDE 018 BK / ZK
			SE SLIDE 020 BK / ZK
			SE SLIDE 022 BK / ZK
			SE SLIDE 024 BK / ZK
2		Full Extension Ball Bearing <b>Soft Close Slide</b> Finish - Zinc Plated Weight Capacity - 45 kgs	SSC 012 ZK
			SSC 014 ZK
			SSC 016 ZK
			SSC 018 ZK
			SSC 020 ZK
			SSC 022 ZK
3		53mm Full Extension Ball Bearing <b>Heavy Duty Slide</b> Finish - Zinc Plated Capacity - 100 kgs	MAXX 012 ZK
			MAXX 014 ZK
			MAXX 016 ZK
			MAXX 018 ZK
			MAXX 020 ZK
			MAXX 022 ZK
			MAXX 024 ZK
			MAXX 026 ZK
			MAXX 028 ZK
			MAXX 030 ZK
			MAXX 032 ZK
			MAXX 034 ZK
			MAXX 036 ZK
			MAXX 038 ZK
			MAXX 040 ZK
MAXX 042 ZK			
4		Under Mount Drawer Runner With <b>2D Catch</b> Full Extension Finish - Zinc Plated Weight Capacity - 30 kgs	STR 010"
			STR 012"
			STR 014"
			STR 016"
			STR 018"
			STR 020"
			STR 022"
5		Under Mount Drawer Runner Full Extension With <b>3D Adjustable Catch</b> Finish - Zinc Plated Weight Capacity - 40 Kgs	STR 3D 010
			STR 3D 012
			STR 3D 014
			STR 3D 016
			STR 3D 018
			STR 3D 020
			STR 3D 022
STR 3D 024			

SR.	IMAGE	DESCRIPTION	ITEM CODE
6		<b>Push Open Under Mount Drawer Runner Full Extension With 3D Adjustable Catch</b> Finish - Zinc Plated Weight Capacity - 30 kgs	STRPO 012"
			STRPO 014"
			STRPO 016"
			STRPO 018"
			STRPO 020"
			STRPO 022"
			STRPO 024"

## BED FITTING







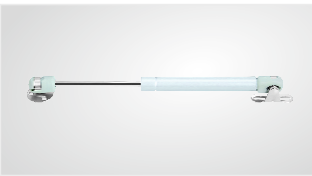
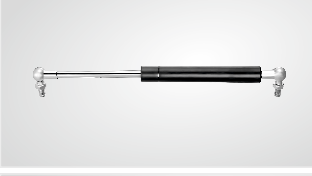

SR.	IMAGE	ITEM CODE	DESCRIPTION	PER
1		SBF 1200	Bed Fitting Frame 1200mm	SET
		SBF 1500	Bed Fitting Frame 1500mm	SET
2		SBFG 075	Bed Fitting Gas Pump 75kg	SET
		SBFG 100	Bed Fitting Gas Pump 100kg	SET
		SBFG 125	Bed Fitting Gas Pump 125kg	SET
		SBFG 150	Bed Fitting Gas Pump 150kg	SET
		SBFG 175	Bed Fitting Gas Pump 175kg	SET
		SBFG 200	Bed Fitting Gas Pump 200kg	SET
		SBFG 225	Bed Fitting Gas Pump 225kg	SET
		SBFG 240	Bed Fitting Gas Pump 240kg	SET
SBFG 250	Bed Fitting Gas Pump 250kg	SET		

## DINING BRACKETS

SR.	IMAGE	ITEM CODE	DESCRIPTION	PER
1		SDTB 030	Dining Table Bracket 750mm	SET
		SDTB 036	Dining Table Bracket 900mm	
		SDTB 048	Dining Table Bracket 1200mm	

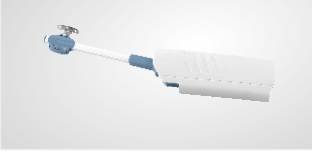
**FOLDING BRACKET**

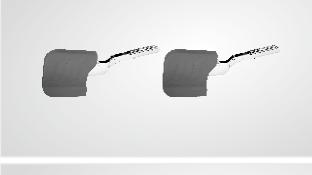
SR.	IMAGE	ITEM CODE	DESCRIPTION	PER	
1		STF 012	Table Folding Bracket 300mm	SET	
		STF 014	Table Folding Bracket 350mm	SET	
		STF 016	Table Folding Bracket 400mm	SET	
		STF 018	Table Folding Bracket 450mm	SET	
		STF 020	Table Folding Bracket 500mm	SET	
		STF 022	Table Folding Bracket 550mm	SET	
		STF 024	Table Folding Bracket 600mm	SET	

SR.	IMAGE	ITEM CODE	DESCRIPTION	PER	
1		SGS 001-9"	Gas Pump 9" 5/10/15/20/25/30/35 Kgs. Material - MS+Steel+Pvc Max. Door Height Required 300mm.	SET	
2		SGS 003-12"	Gas Pump 12" 5/10/15/20/25/30/35/50 Kgs. Material - MS+Steel	SET	
3		SGS 004-15"	Gas Pump 15" 5/10/15/20/25/30/35/50 Kgs. Material - MS+Steel	SET	
4		SCF 001	Hold Open Flap Stay Material - Zinc Alloy Weight Capacity - 5kgs Applicable - All Kinds Of Cabinet Doors.	PCS	
5		SCF 002 L/R	Flap Stay (pneumatic) Material - Zinc Alloy Weight Capacity - 5kgs. Applicable - All Kinds Of Cabinet Doors.	PCS	
6		SCF 003 L/R	Extra Heavy Duty Lid Stay Material - Zinc Alloy Weight Capacity - Upto 7kgs Applicable - All Kinds Of Cabinet Doors.	PCS	
7		SCF 004 L/R	Hold Open Flap Stay Material - Steel+PVC Weight capacity - 8-10kgs. Cabinet width 1600mm. Heigh 400mm	PCS	
8		SCF 005 L	Bi-fold Liftup System Height: 600-650mm; Width: 900mm Weight: 4 to 6 kgs	SET	
		SCF 005 M	Height: 700-850mm; Width: 900mm Weight: 7 to 8 kgs		
		SCF 005 H	Height: 900-950mm; Width: 900mm Weight: 9 to 11 kgs		
9		SCF 008 L	Hold Open Flap Stay Without Auto Hinges H: 300-500mm; W: 600-1200mm; C: 2.5-4 Kg	SET	
		SCF 008 M	H: 300-500mm; W: 600-1200mm; C: 4-5 Kg		
		SCF 008 H	H: 300-500mm; W: 600-1200mm; C: 5-6 Kg		
10		SCF 009	Bi-fold Liftup System (Heavy) Height: Upto 1000mm Width: 900mm Weight: 14 Kgs	SET	

**SR. 1 SSB-1040 SMART BOX DRAWER SYSTEM HEIGHT - 84MM**



Finish - Iron Gray / White  
Load Capacity - 40 kgs



ITEM CODE	UNIT	300mm	350mm	400mm	450mm	500mm	550mm	600mm
SSB 1040 IG/WT	1 SET							

**SR. 2 SSB-1040 SMART BOX DRAWER SYSTEM HEIGHT - 116MM**



Finish - Iron Gray / White  
Load Capacity - 40 kgs



ITEM CODE	UNIT	300mm	350mm	400mm	450mm	500mm	550mm	600mm
SSB 1040 IG/WT	1 SET							

**SR. 3 SSB-1040 SMART BOX DRAWER SYSTEM HEIGHT - 199MM**



Finish - Iron Gray / White  
Load Capacity - 40 kgs



ITEM CODE	UNIT	300mm	350mm	400mm	450mm	500mm	550mm	600mm
SSB 1040 IG/WT	1 SET							

**SR. 4 SSB-1040 SMART BOX INNER DRAWER SYSTEM HEIGHT - 84MM**

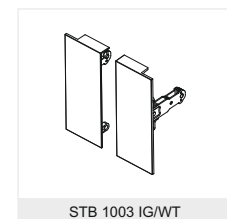
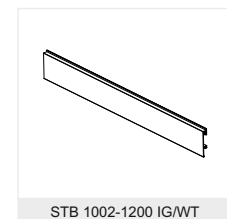

ITEM CODE	UNIT	300mm	350mm	400mm	450mm	500mm	550mm	600mm
SSB 1040 IG/WT	1 SET							
STB 1002-1200 IG/WT	1 PCS							
STB 1003 IG/WT	1 SET							
<b>MRP</b>	<b>1 SET</b>							

## SR. 5 SSB-1040 SMART BOX INNER DRAWER SYSTEM HEIGHT - 116MM

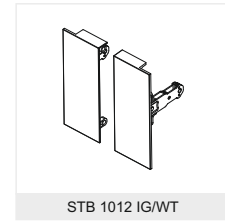
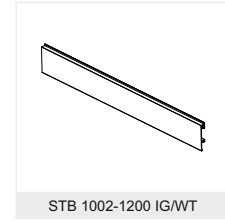

ITEM CODE	UNIT	300mm	350mm	400mm	450mm	500mm	550mm	600mm
SSB 1040 IG/WT	1 SET							
STB 1002-1200 IG/WT	1 PCS							
STB 1012 IG/WT	1 SET							
<b>MRP</b>	<b>1 SET</b>							

## SR. 6 SSB-1040 SMART BOX INNER DRAWER SYSTEM HEIGHT - 84MM

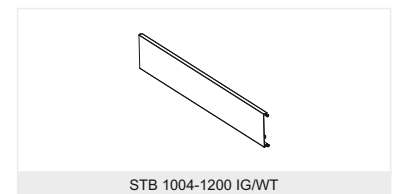
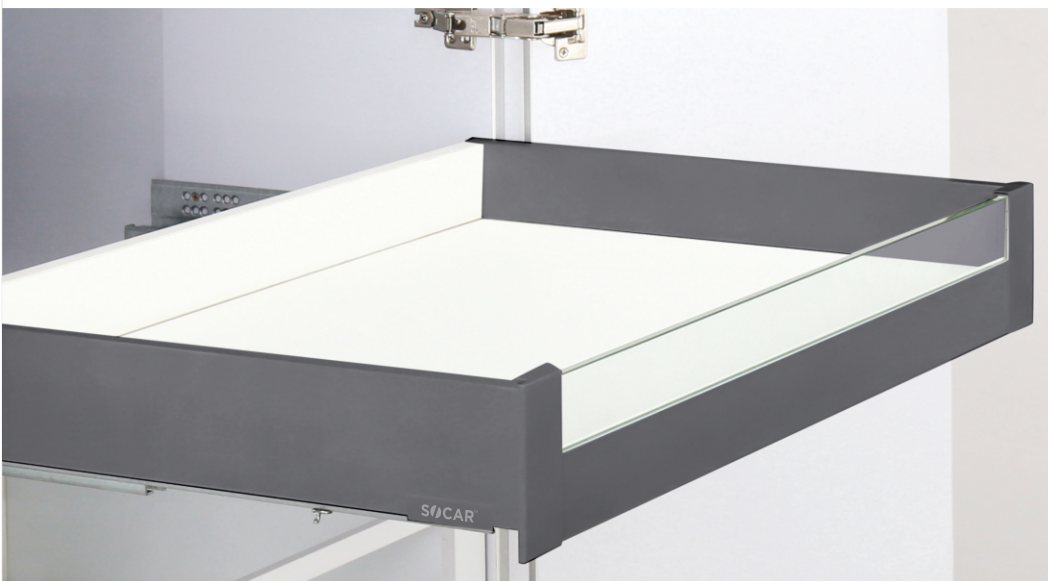

ITEM CODE	UNIT	300mm	350mm	400mm	450mm	500mm	550mm	600mm
SSB 1040 IG/WT								
STB 1004-1200 IG/WT								
STB 1008 A IG/WT								
<b>MRP</b>								

**SR. 7 SSB-1040 SMART BOX INNER DRAWER SYSTEM HEIGHT - 199MM**

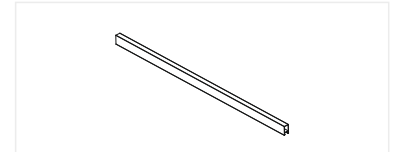

STB 1105-1200 IG/WT

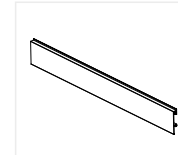

STB 1002-1200 IG/WT

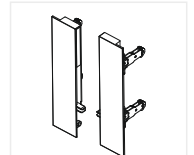

STB 1004 A IG/WT



ITEM CODE	UNIT	300mm	350mm	400mm	450mm	500mm	550mm	600mm
SSB 1040 IG/WT	1 SET							
STB 1105-1200 IG/WT	1 PCS							
STB 1002-1200 IG/WT	1 PCS							
STB 1004 A IG/WT	1 SET							
<b>MRP</b>	<b>1 SET</b>							

**SR. 8 SSB-1040 SMART BOX INNER DRAWER SYSTEM HEIGHT - 199MM**

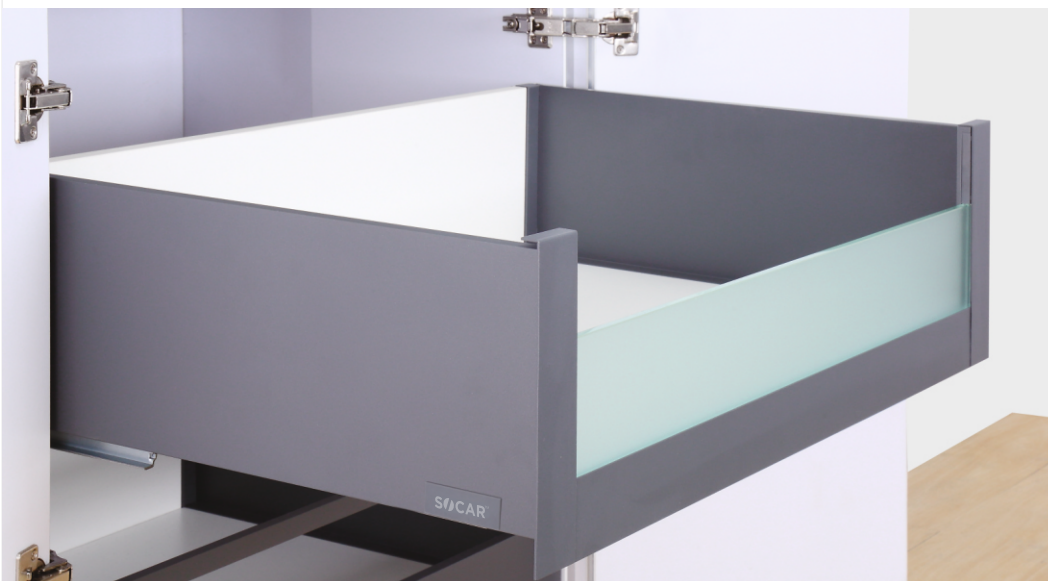

STB 1004-1200 IG/WT

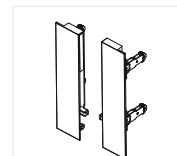

STB 1004 B IG/WT



ITEM CODE	UNIT	300mm	350mm	400mm	450mm	500mm	550mm	600mm
SSB 1040 IG/WT	1 SET							
STB 1004-1200 IG/WT	1 PCS							
STB 1004 B IG/WT	1 SET							
<b>MRP</b>	<b>1 SET</b>							

Note: Front Glass Will Be Extra

**SR. 9 SSB-1040 SMART BOX INNER DRAWER SYSTEM HEIGHT - 199MM**

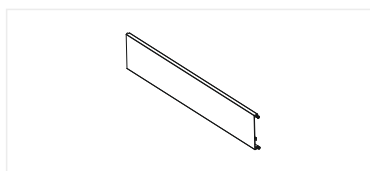

STB 1004-1200 IG/WT

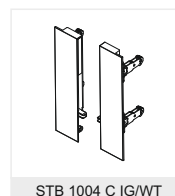

STB 1004 C IG/WT



ITEM CODE	UNIT	300mm	350mm	400mm	450mm	500mm	550mm	600mm
SSB 1040 IG/WT	1 SET							
STB 1004-1200 IG/WT	1 PCS							
STB 1004 C IG/WT	1 SET							
<b>MRP</b>	<b>1 SET</b>							

Note: Front Glass Will Be Extra

**SR. 1 SSB-3040 GLASS BOX DRAWER SYSTEM HEIGHT - 84MM**



Finish - Iron Gray / White  
Load Capacity - 40 kgs



ITEM CODE	UNIT	450mm	500mm	550mm
SSB 3040 IG	1 SET			

**SR. 2 SSB-3040 GLASS BOX DRAWER SYSTEM HEIGHT - 167MM**



Finish - Iron Gray / White  
Load Capacity - 40 kgs



ITEM CODE	UNIT	450mm	500mm	550mm
SSB 3040 IG	1 SET			

**SR. 3 SSB-3040 GLASS BOX DRAWER SYSTEM HEIGHT - 199MM**



Finish - Iron Gray / White  
Load Capacity - 40 kgs



ITEM CODE	UNIT	450mm	500mm	550mm
SSB 3040 IG	1 SET			

**SR. 4 SSB-3040 GLASS BOX INNER DRAWER SYSTEM HEIGHT - 84MM**

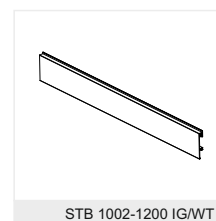
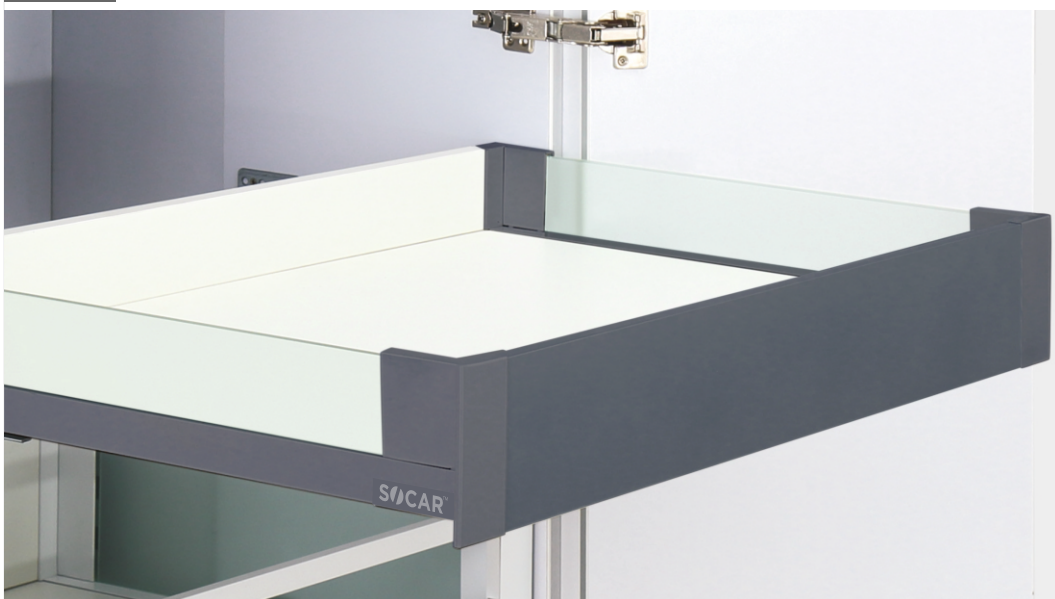

ITEM CODE	UNIT	450mm	500mm	550mm
SSB 3040 IG	1 SET			
STB 1002-1200 IG/WT	1 PCS			
STB 1003 IG/WT	1 SET			
<b>MRP</b>	<b>1 SET</b>			

## SR. 5 SSB-3040 GLASS BOX INNER DRAWER SYSTEM HEIGHT - 84MM

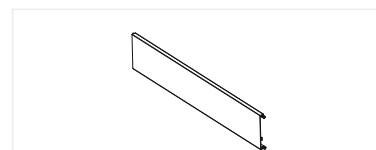
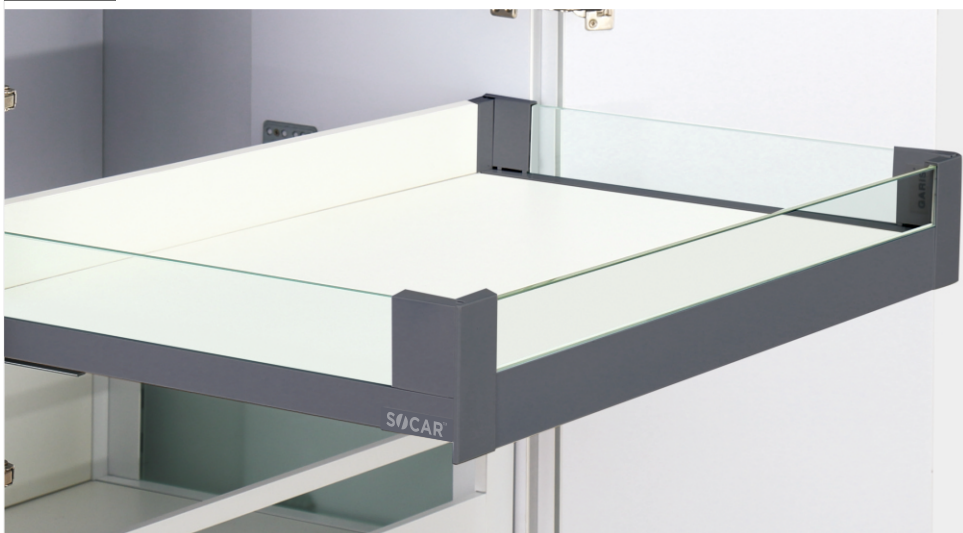

STB 1004-1200 IG/WT

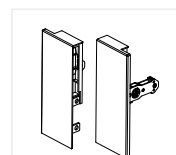

STB 1008 A IG/WT



ITEM CODE	UNIT	450mm	500mm	550mm
SSB 3040 IG	1 SET			
STB 1004-1200 IG/WT	1 PCS			
STB 1008 A IG/WT	1 SET			
<b>MRP</b>	<b>1 SET</b>			

Note: Front Glass Will Be Extra

## SR. 6 SSB-3040 GLASS BOX INNER DRAWER SYSTEM HEIGHT - 167MM

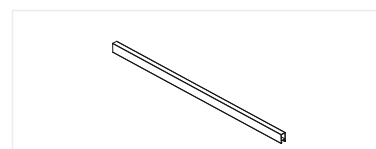
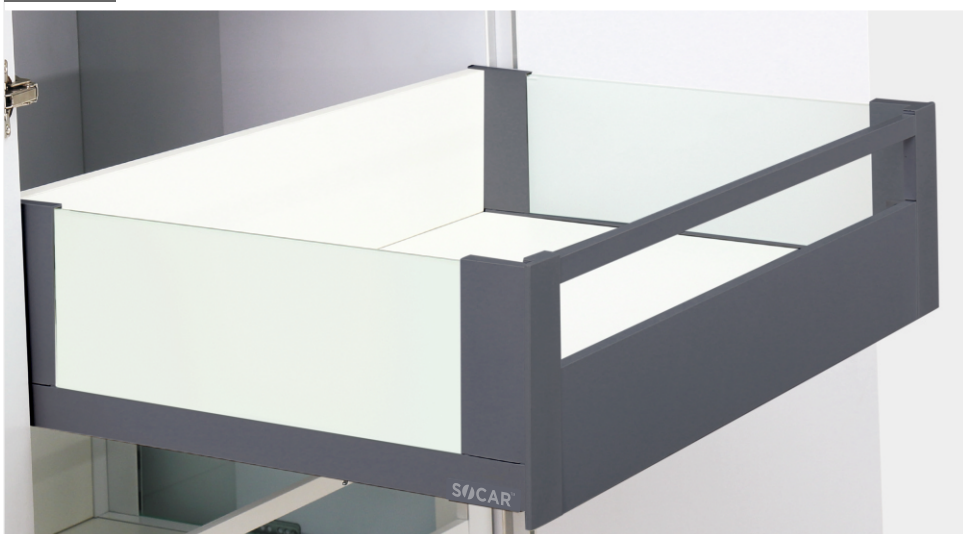

STB 1105-1200 IG/WT

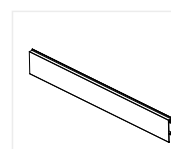

STB 1002-1200 IG/WT

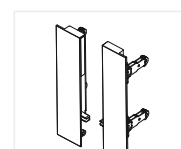

STB 1005 A IG/WT



ITEM CODE	UNIT	450mm	500mm	550mm
SSB 3040 IG	1 SET			
STB 1105-1200 IG/WT	1 PCS			
STB 1005 A IG/WT	1 SET			
STB 1002-1200 IG/WT	1 PCS			
<b>MRP</b>	<b>1 SET</b>			

## SR. 7 SSB-3040 GLASS BOX INNER DRAWER SYSTEM HEIGHT - 167MM

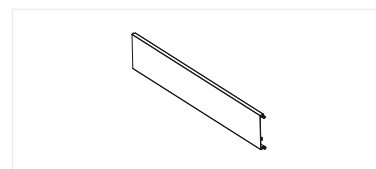

STB 1004-1200 IG/WT

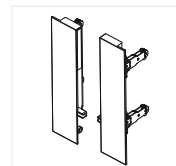

STB 1005 B IG/WT



ITEM CODE	UNIT	450mm	500mm	550mm
SSB 3040 IG	1 SET			
STB 1004-1200 IG/WT	1 PCS			
STB 1005 B IG/WT	1 SET			
<b>MRP</b>	<b>1 SET</b>			

Note: Front Glass Will Be Extra

## SR. 8 SSB-3040 GLASS BOX INNER DRAWER SYSTEM HEIGHT - 167MM

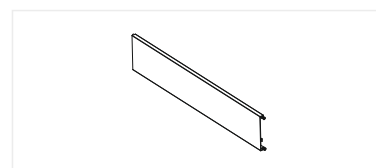
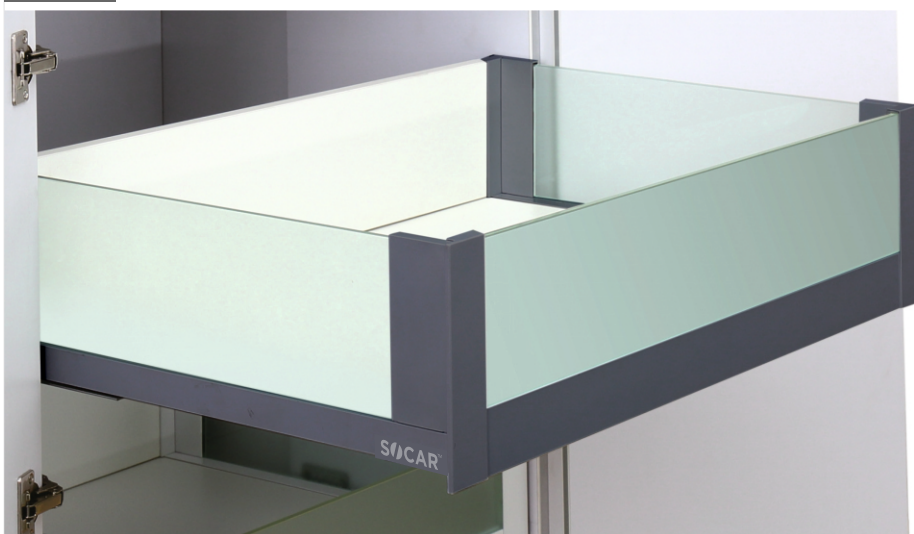

STB 1004-1200 IG/WT

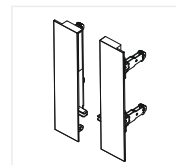

STB 1005 C IG/WT



ITEM CODE	UNIT	450mm	500mm	550mm
SSB 3040 IG	1 SET			
STB 1004-1200 IG/WT	1 PCS			
STB 1005 C IG/WT	1 SET			
<b>MRP</b>	<b>1 SET</b>			

Note: Front Glass Will Be Extra

## SR. 9 SSB-3040 GLASS BOX INNER DRAWER SYSTEM HEIGHT - 199MM

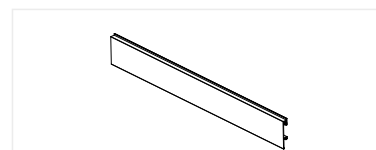
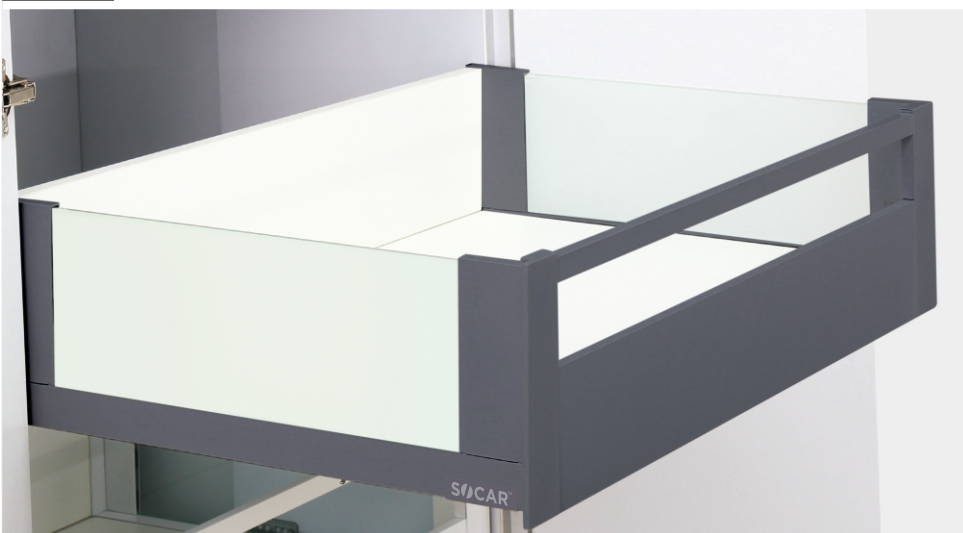

STB 1002-1200 IG/WT

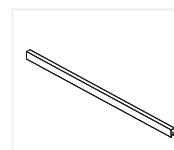

STB 1105-1200 IG/WT

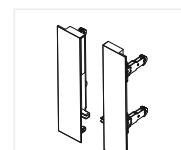

STB 1004 A IG/WT



ITEM CODE	UNIT	450mm	500mm	550mm
SSB 3040 IG	1 SET			
STB 1002-1200 IG/WT	1 PCS			
STB 1004 A IG/WT	1 SET			
STB 1105-1200 IG/WT	1 PCS			
<b>MRP</b>	<b>1 SET</b>			

Note: Front Glass Will Be Extra

## SR. 10 SSB-3040 GLASS BOX INNER DRAWER SYSTEM HEIGHT - 199MM

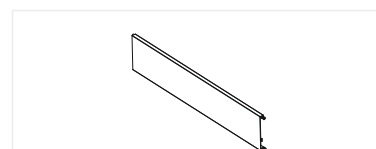

STB 1004-1200 IG/WT

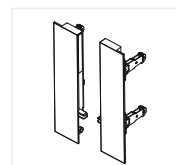

STB 1004 B IG/WT



ITEM CODE	UNIT	450mm	500mm	550mm
SSB 3040 IG	1 SET			
STB 1004-1200 IG/WT	1 SET			
STB 1004 B IG/WT	1 SET			
<b>MRP</b>	<b>1 SET</b>			

**SR. 11 SSB-3040 GLASS BOX INNER DRAWER SYSTEM HEIGHT - 199M**

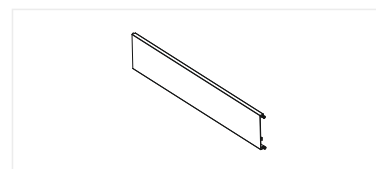
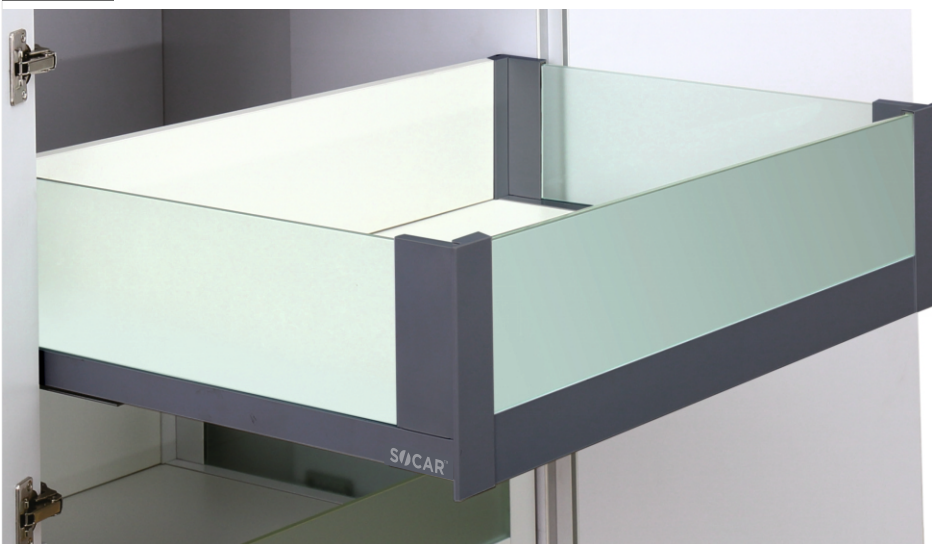

STB 1004-1200 IG/WT

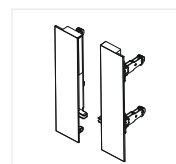

STB 1004 C IG/WT



ITEM CODE	UNIT	450mm	500mm	550mm
SSB 3040 IG	1 SET			
STB 1004-1200 IG/WT	1 PCS			
STB 1004 C IG/WT	1 SET			
<b>MRP</b>	<b>1 SET</b>			

Note: Front Glass Will Be Extra



**SR. 1 M-TEK STANDARD DRAWER SYSTEM HEIGHT - 84MM**

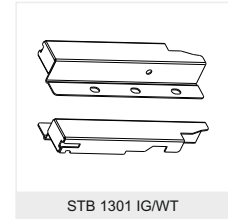

ITEM CODE	UNIT	300mm	350mm	400mm	450mm	500mm	550mm
STB 2040 IG/WT	1 SET						
STB 1301 IG/WT	1 SET						
<b>MRP</b>	<b>1 SET</b>						

**SR. 2 M-TEK SINGLE ROUND GALLERY DRAWER SYSTEM HEIGHT - 119MM**

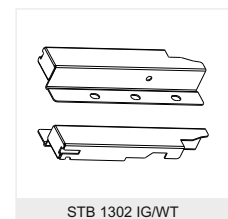
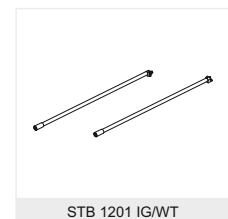

ITEM CODE	UNIT	300mm	350mm	400mm	450mm	500mm	550mm
STB 2040 IG/WT	1 SET						
STB 1201 IG/WT	1 SET						
STB 1302 IG/WT	1 SET						
<b>MRP</b>	<b>1 SET</b>						

## SR. 3 M-TEK SINGLE ROUND GALLERY DRAWER SYSTEM HEIGHT - 151MM

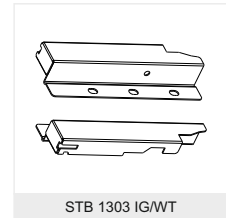
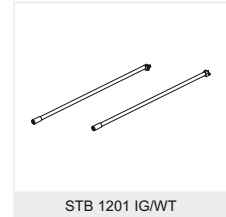

ITEM CODE	UNIT	300mm	350mm	400mm	450mm	500mm	550mm
STB 2040 IG/WT	1 SET						
STB 1201 IG/WT	1 SET						
STB 1303 IG/WT	1 SET						
<b>MRP</b>	<b>1 SET</b>						

## SR. 4 M-TEK DOUBLE ROUND GALLERY DRAWER SYSTEM HEIGHT - 183MM

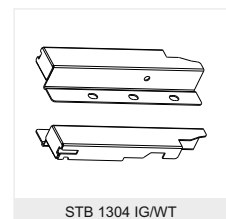
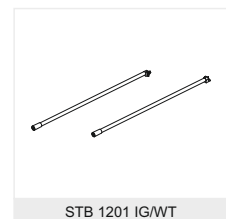

ITEM CODE	UNIT	300mm	350mm	400mm	450mm	500mm	550mm
STB 2040 IG/WT	1 SET						
STB 1201 IG/WT	2 SET						
STB 1304 IG/WT	1 SET						
<b>MRP</b>	<b>1 SET</b>						

**SR. 5 M-TEK SINGLE SQUARE GALLERY DRAWER SYSTEM HEIGHT - 119MM**



ITEM CODE	UNIT	300mm	350mm	400mm	450mm	500mm	550mm
STB 2040 IG/WT	1 SET						
STB 1101 IG/WT	1 SET						
STB 1302 IG/WT	1 SET						
<b>MRP</b>	<b>1 SET</b>						

**SR. 6 M-TEK SINGLE SQUARE GALLERY DRAWER SYSTEM HEIGHT - 151MM**



ITEM CODE	UNIT	300mm	350mm	400mm	450mm	500mm	550mm
STB 2040 IG/WT	1 SET						
STB 1101 IG/WT	1 SET						
STB 1303 IG/WT	1 SET						
<b>MRP</b>	<b>1 SET</b>						

**SR. 7 M-TEK DOUBLE SQUARE GALLERY DRAWER SYSTEM HEIGHT - 183MM**

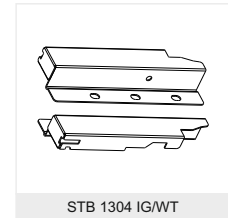

ITEM CODE	UNIT	300mm	350mm	400mm	450mm	500mm	550mm
STB 2040 IG/WT	1 SET						
STB 1101 IG/WT	2 SET						
STB 1304 IG/WT	1 SET						
<b>MRP</b>	<b>1 SET</b>						

**SR. 8 M-TEK DRAWER BOX WITH SIDE GLASS SYSTEM HEIGHT - 151MM**

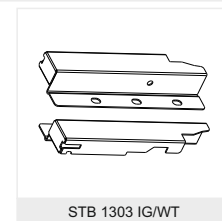
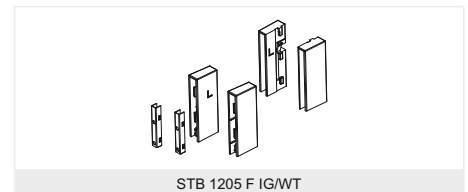

ITEM CODE	UNIT	350mm	400mm	450mm	500mm	550mm
STB 2040 IG/WT	1 SET					
STB 1205 F IG/WT	1 SET					
STB 1303 IG/WT	1 SET					
<b>MRP</b>	<b>1 SET</b>					

## SR. 9 M-TEK DRAWER BOX WITH SIDE GLASS SYSTEM HEIGHT - 183MM

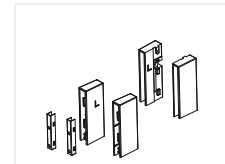

STB 1206 F IG/WT

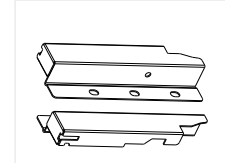

STB 1304 IG/WT



ITEM CODE	UNIT	350mm	400mm	450mm	500mm	550mm
STB 2040 IG/WT	1 SET					
STB 1206 F IG/WT	1 SET					
STB 1304 IG/WT	1 SET					
<b>MRP</b>	<b>1 SET</b>					

## SR. 10 M-TEK DRAWER BOX WITH SIDE GLASS & SQUARE GALLERY SYSTEM HEIGHT - 151MM



STB 1101 IG/WT

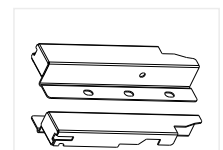

STB 1303 IG/WT

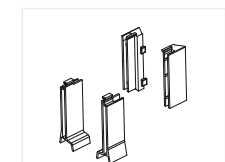

STB 1207 F IG/WT



ITEM CODE	UNIT	400mm	450mm	500mm	550mm
STB 2040 IG/WT	1 SET				
STB 1101 IG/WT	1 SET				
STB 1303 IG/WT	1 SET				
STB 1207 F IG/WT	1 SET				
<b>MRP</b>	<b>1 SET</b>				

## SR. 11 M-TEK BOX WITH INNER DRAWER SYSTEM HEIGHT - 84MM

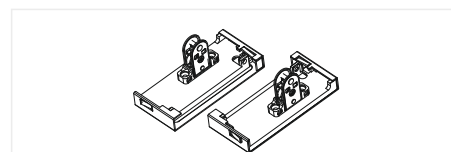

STB 1203 IG/WT

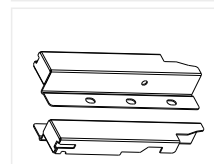

STB 1301 IG/WT

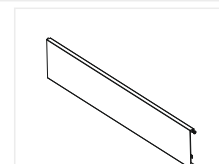

STB 1202-1200 IG/WT



ITEM CODE	UNIT	300mm	350mm	400mm	450mm	500mm	550mm
STB 2040 IG/WT	1 SET						
STB 1301 IG/WT	1 SET						
STB 1203 IG/WT	1 SET						
STB 1202-1200 IG/WT	1 SET						
<b>MRP</b>	<b>1 SET</b>						

## SR. 12 M-TEK BOX WITH INNER DRAWER SYSTEM HEIGHT - 151MM

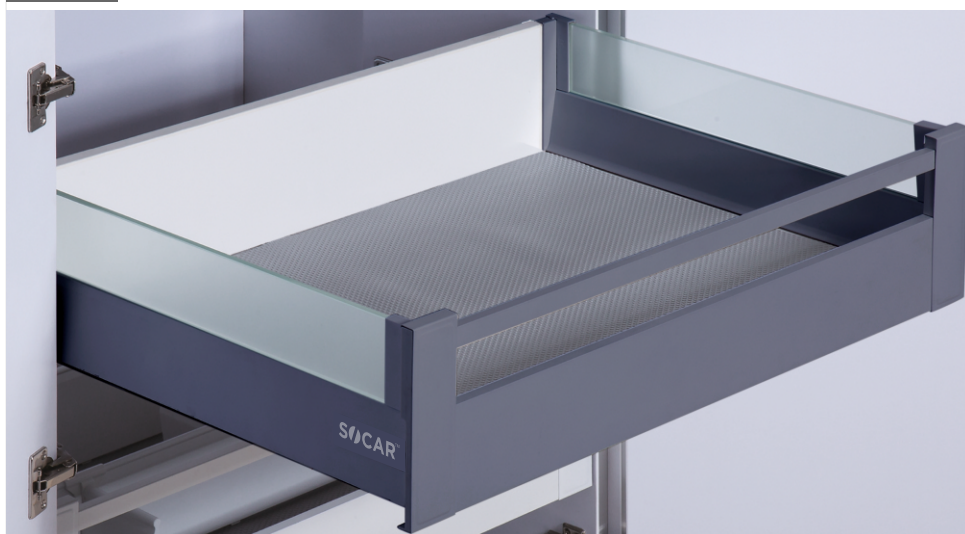

STB 1105-1200 IG/WT



STB 1202-1200 IG/WT



STB 1205A IG/WT



STB 1205F IG/WT

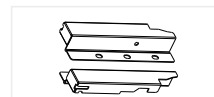

STB 1303 IG/WT



ITEM CODE	UNIT	350mm	400mm	450mm	500mm	550mm
STB 2040 IG/WT	1 SET					
STB 1105-1200 IG/WT	1 PCS					
STB 1202-1200 IG/WT	1 PCS					
STB 1205A IG/WT	1 SET					
STB 1205F IG/WT	1 SET					
STB 1303 IG/WT	1 SET					
<b>MRP</b>	<b>1 SET</b>					

## SR. 13 M-TEK BOX WITH INNER DRAWER SYSTEM HEIGHT - 183MM

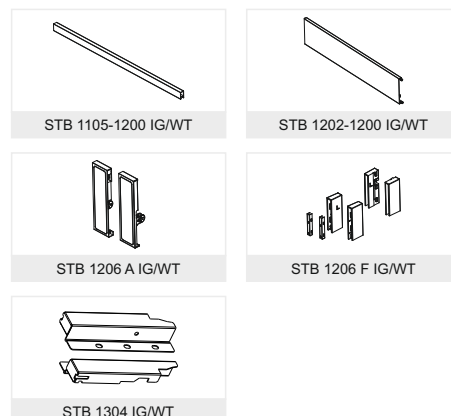

ITEM CODE	UNIT	350mm	400mm	450mm	500mm	550mm
STB 2040 IG/WT	1 SET					
STB 1105-1200 IG/WT	1 PCS					
STB 1202-1200 IG/WT	1 PCS					
STB 1206 A IG/WT	1 SET					
STB 1206 F IG/WT	1 SET					
STB 1304 IG/WT	1 SET					
<b>MRP</b>	<b>1 SET</b>					

## SR. 14 M-TEK BOX WITH INNER DRAWER SYSTEM HEIGHT - 151MM

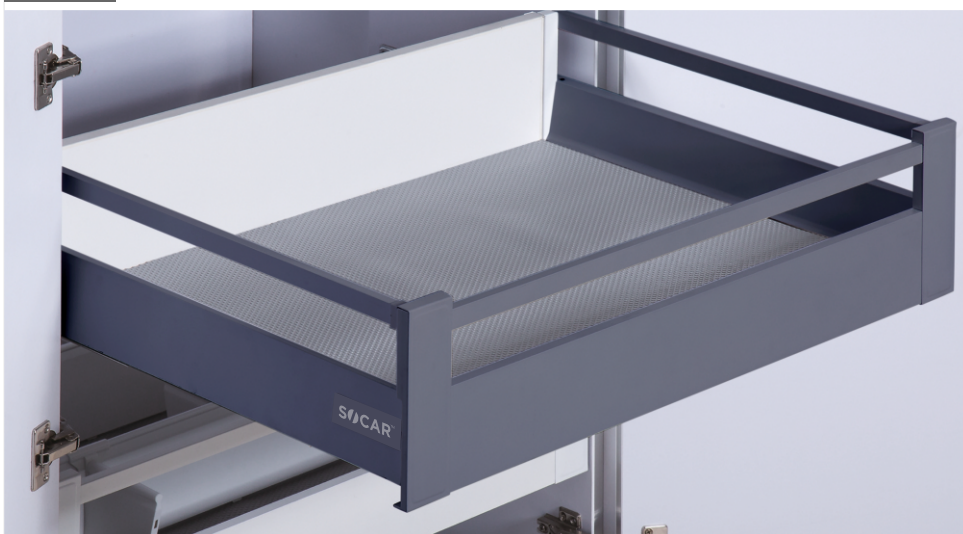

ITEM CODE	UNIT	300mm	350mm	400mm	450mm	500mm	550mm
STB 2040 IG/WT	1 SET						
STB 1105-1200 IG/WT	1 PCS						
STB 1202-1200 IG/WT	1 PCS						
STB 1101 IG/WT	1 SET						
STB 1205 A IG/WT	1 SET						
STB 1303 IG/WT	1 SET						
<b>MRP</b>	<b>1 SET</b>						

## SR. 15 M-TEK BOX WITH INNER DRAWER SYSTEM HEIGHT - 151 MM

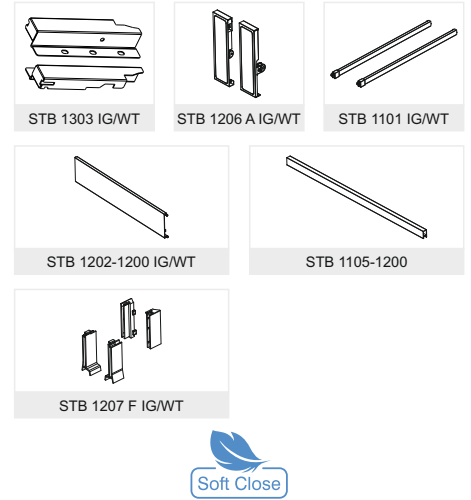
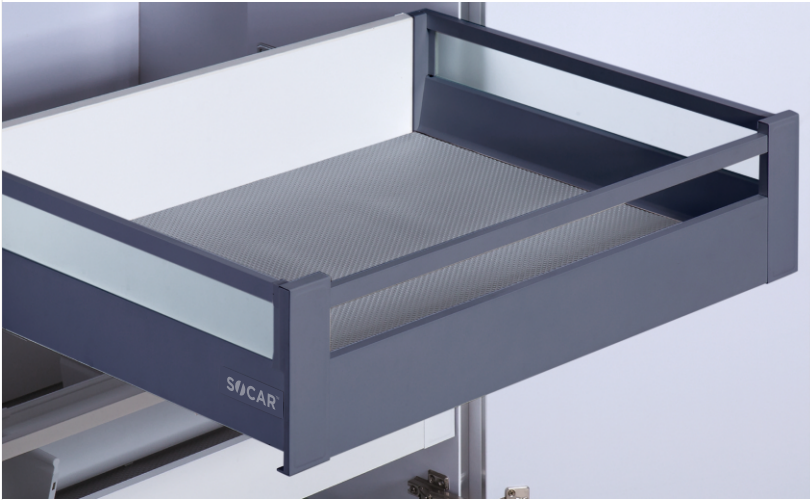





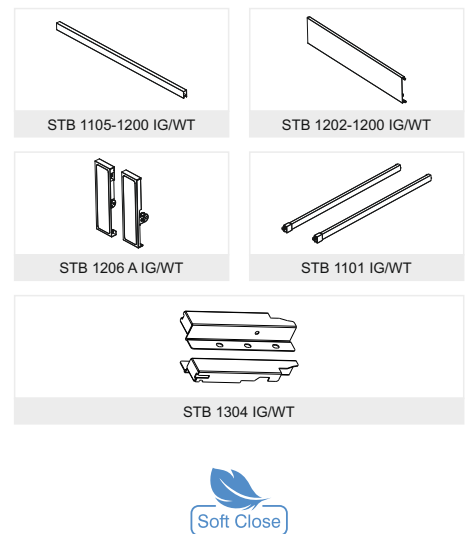

ITEM CODE	UNIT	400mm	450mm	500mm	550mm
STB 2040 IG/WT	1 SET				
STB 1303 IG/WT	1 SET				
STB 1207 F IG/WT	1 SET				
STB 1101 IG/WT	1 SET				
STB 1202-1200 IG/WT	1 PCS				
STB 1105-1200 IG/WT	1 PCS				
STB 1206 A IG/WT	1 SET				
<b>MRP</b>	<b>1 SET</b>				

## SR. 16 M-TEK BOX WITH INNER DRAWER SYSTEM HEIGHT - 183MM



ITEM CODE	UNIT	300mm	350mm	400mm	450mm	500mm	550mm
STB 2040 IG/WT	1 SET						
STB 1105-1200 IG/WT	1 PCS						
STB 1202-1200 IG/WT	1 PCS						
STB 1206 A IG/WT	1 SET						
STB 1101 IG/WT	1 SET						
STB 1304 IG/WT	1 SET						
<b>MRP</b>	<b>1 SET</b>						









SR.	IMAGE	ITEM CODE	DESCRIPTION	FINISH	PER	
1		SKA 202-450	<b>SUPER MAGIC CORNER</b> W:800 x D:550 x H:610 - 730	CHROME	SET	
		SKA 302-450		BLACK		
2		SKA 203-450 L/R	<b>SWING CORNER</b> W:900 x D:500 x H:650 - 740	CHROME	SET	
		SKA 303-450 L/R		BLACK		
3		SKA 204-200 L/R	<b>SIDE PULLOUT</b> W:200 x D:500 x H:650 - 750	CHROME	SET	
		SKA 204-300 L/R	W:300 x D:500 x H:650 - 750	CHROME		
		SKA 304-200 L/R	W:200 x D:500 x H:650 - 750	BLACK		
		SKA 304-300 L/R	W:300 x D:500 x H:650 - 750	BLACK		
4		SKA 208-450 L/R	<b>PANTRY UNIT</b> W:450 x D:550 x H:2000 - 2100	CHROME	SET	
		SKA 208-600 L/R	W:600 x D:550 x H:2000 - 2100	CHROME		
		SKA 308-450 L/R	W:450 x D:550 x H:2000 - 2100	BLACK		
		SKA 308-600 L/R	W:600 x D:550 x H:2000 - 2100	BLACK		
5		SKA 215-600 L/R	<b>GLASS TRAY PLATE TRAY</b> W:600 x D:330 x H:720	S.S	SET	
		SKA 215-800 L/R	W:800 x D:330 x H:720			
		SKA 215-900 L/R	W:900 x D:330 x H:720			
6		SKA 230-450	<b>WICKER BASKET</b> W:410 x D:500 x H:100	WOODEN	PCS	
			W:410 x D:500 x H:150			
			W:410 x D:500 x H:200			
		SKA 230-600	W:560 x D:500 x H:100			
			W:560 x D:500 x H:150			
			W:560 x D:500 x H:200			
7		SKA 229-500	<b>ANTI SLIP MATT</b> 500mm x 20mtr.	ROLL		
		SKA 229-550	550mm x 20mtr.			

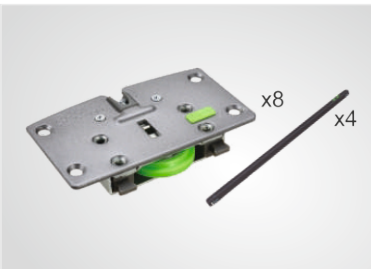



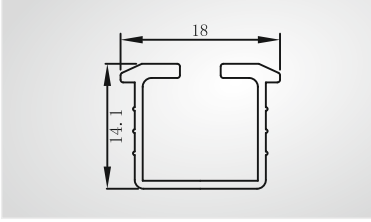
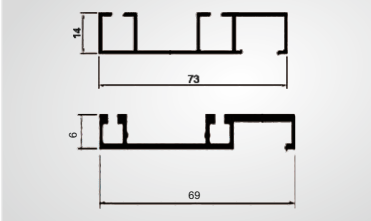
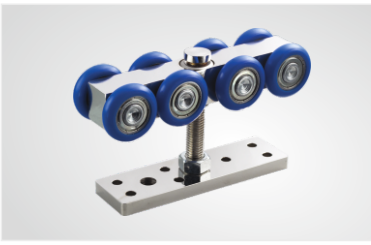

SR.	IMAGE	ITEM CODE	DESCRIPTION	FINISH	PER	
8		STH 001-500mm	<b>THALI INSERT</b> Depth - 500mm	S.S	PCS	
		STH 001-550mm	Depth - 550mm	S.S	PCS	
9		SCS 001-500mm	<b>CUP SAUCER INSERT</b> Depth - 500mm	S.S	PCS	
		SCS 001-550mm	Depth - 550mm	S.S	PCS	
10		SKA 216	<b>ADJUSTABLE PLATE HOLDER</b>	GREY	PCS	
11		<b>(500mm Depth)</b>	<b>PVC CUTLERY TRAY</b>	PVC GREY	PCS	
		SKA 231-450	W:380 × D:483 × H:50		PCS	
		SKA 231-500	W:430 × D:483 × H:50		PCS	
		SKA 231-600	W:530 × D:483 × H:50		PCS	
		SKA 231-800	W:730 × D:483 × H:50		PCS	
		SKA 231-900	W:830 × D:483 × H:50	PCS		
		<b>(550mm Depth)</b>	SKA 331-450	W:380 × D:530 × H:50	PVC GREY	PCS
		SKA 331-500	W:430 × D:530 × H:50	PCS		
		SKA 331-600	W:530 × D:530 × H:50	PCS		
		SKA 331-800	W:730 × D:530 × H:50	PCS		
SKA 331-900	W:830 × D:530 × H:50	PCS				
12		<b>(500mm &amp; 550mm depth)</b>	<b>STAINLESS STEEL CUTLERY</b>	S.S MATT	PCS	
		SKA 232-500 A	W:103 × D:474 × H:64		PCS	
		SKA 232-500 B	W:200 × D:474 × H:64		PCS	
		SKA 232-500 C	W:280 × D:474 × H:64		PCS	
		SKA 232-550 A	W:103 × D:524 × H:64		PCS	
		SKA 232-550 B	W:200 × D:524 × H:64		PCS	
		SKA 232-550 C	W:280 × D:524 × H:64		PCS	
	<b>(500mm &amp; 550mm depth)</b> <b>SMART BOX</b>	SKA 233-500 A	W:105 × D:474 × H:64	S.S MATT	PCS	
	SKA 233-500 B	W:202 × D:474 × H:64	PCS			
	SKA 233-500 C	W:291 × D:474 × H:64	PCS			
	SKA 233-550 A	W:105 × D:524 × H:64	PCS			
	SKA 233-550 B	W:202 × D:524 × H:64	PCS			
	SKA 233-550 C	W:291 × D:524 × H:64	PCS			
	13		<b>(500mm Depth)</b>		<b>ADJUSTABLE WOODEN CUTLERY</b>	SOLID WOOD
SKA 234-450			W:450-600 × D:470 × H:60	PCS		
SKA 234-600			W:600-900 × D:470 × H:60	SOLID WOOD	PCS	
<b>(550mm Depth)</b>			SKA 235-450		W:450-600 × D:530 × H:60	PCS
SKA 235-600			W:600-900 × D:530 × H:60		PCS	



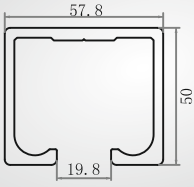

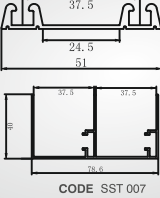

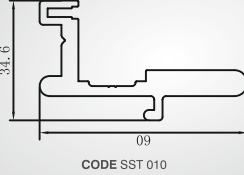
SR.	IMAGE	ITEM CODE	DESCRIPTION	FINISH	PER	
14			<b>SMART ORGANIZER</b>			
		SKA 237-575-500	W:310-585 X D:500	GREY	PCS	
		SKA 237-575-550	W:310-585 X D:550			
		SKA 237-800-500	W:520-790 X D:500			
SKA 237-800-550	W:520-790 X D:550					
15			<b>PVC ROLLING SHUTTER</b>			
		SKA 227-450	W:450 X D:300 X H:1320	SILVER/ BLACK	SET SET SET	
		SKA 227-600	W:600 X D:300 X H:1320			
SKA 227-900	W:900 X D:300 X H:1320					
16		SKA 218	<b>ROUND WASTE BIN</b> W:450 x D:400 x H:450-720	CHROME	PCS	
17		SKA 222	<b>BALL-BEARING WASTE BIN</b> W:400 x D:550 x H:350	GREY	PCS	
18		SKA 223	<b>SOFT CLOSE DOUBLE WASTE BIN</b> W:400 x D:550 x H:350	GREY	PCS	<b>9,540/-</b>
19		SCF 007	<b>CABINET LEG WITH CLIP</b> Height:95mm	BLACK	PCS	

SR.	IMAGE	ITEM CODE	DESCRIPTION	PER	
1		SWSF 001	For 1 Wooden Door. Max. Door Weight- 40kgs/per Panel. Suitable Track: SST 001	SET	
2		SST 001-3000mm	Sliding Track For SWSF 001	ALU	
		SST 001-4000mm	Wooden Sliding Track For SWSF 001	ALU	
				BL	
				ALU	
				BL	
3		SWSF 002	For 1 Wooden Door. Max. Door Weight- 40kgs/per Panel. Suitable Track: SST 002	SET	
4		SST 002-2440mm	Sliding Track For SWSF 002	ALU	
		SST 002-3000mm	Sliding Track For SWSF 002	BL	
		SST 002-3660mm	Sliding Track For SWSF 002	ALU	
				BL	
5		SWSF 003	For 1 Wooden Door. Max. Door Weight- 90kgs/per Panel. Suitable Track: SST 003/ SST 004	SET	
6		SST 003-2440mm	Double Sliding Track For SWSF 003	BL	
		SST 003-3660mm	Double Sliding Track For SWSF 003	ALU	
				BL	
7		SST 004-2440mm	Sliding Track For SWSF 003	ALU	
				BL	
		SST 004-3660mm	Sliding Track For SWSF 003	ALU	
				BL	
8		SWSF 003 SOFT	Soft Close Dampener For SWSF 003 Weight Capacity 60Kgs.	SET	

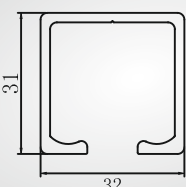
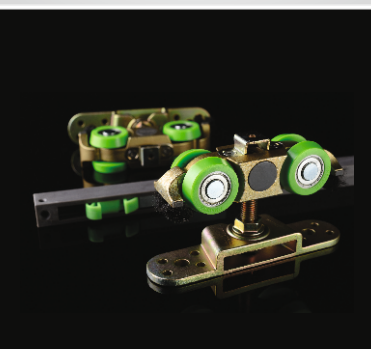

SR.	IMAGE	ITEM CODE	DESCRIPTION	PER
9		SWSF 005	Two Door Both Side Soft Close Sliding Weight Capacity 60kgs/door. Door Thickness 18mm-50mm. Suitable Track: SST 005/SST 031 	SET
10		SWSF 031	Two Door Both Side Soft Close Sliding Weight Capacity 40kgs/door. Door Thickness 18mm-50mm. Suitable Track: SST 005/SST 031 	SET
11		SST 005-2440mm	Sliding Track For SWSF 005 & SWSF 031	ALU BL
		SST 005-3660mm	Sliding Track For SWSF 005 & SWSF 031	ALU BL
12		SST 031-2440mm	Double Sliding Track For SWSF 005 & SWSF 031	ALU BL BG/RG MB
		SST 031-3660mm	Double Sliding Track For SWSF 005 & SWSF 031	ALU BL BG/RG MB
13		SWSF 006	For 1 Wooden Door. Weight Capacity 400kgs/door. Suitable Track: SST 006 	SET
14		SWSF 006 P	Wooden Patch For SWSF006 (1 Set = 2 Pcs) 	SET
15		SWSF 006	Wooden Sliding Fitting	SET
		SGSF 006P	SS 304 Patch For Sliding Roller (1 Door Kit)	SET
		SGSF 012	Complete Glass Sliding System  For 1 Glass Door. Weight Capacity 400kgs/door. Suitable Track: SST 006	SET

SR.	IMAGE	ITEM CODE	DESCRIPTION	PER	
16		SST 006-3000mm	Sliding Track For SWSF 006	ALU	
				BL	
		SST 006-4000mm	Sliding Track For SWSF 006	ALU	
				BL	
17		SWSF 007	2 Door Sliding With Both Side Soft Close & Anti Jump Function. Weight Capacity 80kgs/door. Door Thickness 18mm-35mm. Suitable Track: SST 007	SET	
18		SST 007-2440mm	Sliding Track For SWSF 007	ALU	
				BL	
		SST 007-3660mm	Sliding Track For SWSF 007	ALU	
				BL	
19		SWSF 010	Wooden Sliding Folding Fitting For Wardrobe For 2+2 Folding Door Per Panel Weight Up To 25kgs. Door Height Up To 2400mm. Door Width Up To 600mm. Suitable Track: SST 010	SET	
20		SST 010-2440mm	Sliding Track For SWSF 010	ALU	
				BL	
21		SWSF 011	For 1 Wooden Door. Weight Capacity - 80kgs/door. Suitable Track: SST 011	SET	
22		SWSF 012	For 1 Wooden Door. Weight Capacity - 120kgs/door. Suitable Track: SST 011	SET	

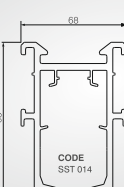
SR.	IMAGE	ITEM CODE	DESCRIPTION	PER
23		SWSF 011	For 2 Wooden Door. Weight Capacity 80kgs/door. Suitable Track: SST 011 <b>Wooden Sliding Fitting(2 Door Kit)</b>	SET
		SWSF 008	<b>Sliding Synchro System Kit</b>	SET
		SWSF 011 H	<b>Complete Synchro System</b>	SET
24		SWSF 012	For 2 Wooden Door. Weight Capacity 100kgs/door. Suitable Track: SST 011 <b>Wooden Sliding Fitting(2 Door Kit)</b>	SET
		SWSF 008	<b>Sliding Synchro System Kit</b>	SET
		SWSF 012 H	<b>Complete Synchro System</b>	SET
25		SWSF 011	For 1 Glass Door. Weight Capacity 80kgs/door. Suitable Track: SST 011 <b>Sliding Fitting</b>	SET
		SGSF 011 P	<b>Sus 304 Patch For Sliding Roller</b>	SET
		SGSF 011	<b>Complete Glass Sliding System</b>	SET
26		SWSF 011	For 10 to 12 mm Glass. Weight Capacity 80kgs/door. Suitable Track: SST 011 <b>Wooden Sliding Fitting (2 Door Kit)</b>	SET
		SGSF 011 P	<b>Sus 304 Patch For Sliding Roller (2 Door Kit)</b>	SET
		SGSF 008	<b>Synchro Cable System</b>	SET
		SGSF 008 P	<b>Synchro Cable Connector Clamp</b>	SET
		SGSF 011 H	<b>Complete Glass Sliding Synchro System</b>	SET
27		SST 011-2440mm	Sliding Track For SWSF 011	ALU/BL CG/RG MB/PG
		SST 011-3660mm	Sliding Track For SWSF 011	ALU/BL CG/RG MB/PG
28		SWSF 014	Soft Close Sliding Fitting For Door Weight Capacity 300kgs. Minimum Door Width 620mm. Applicable For Solid Wooden/metal Doors. Suitable Track: SST 014 	SET
29		SST 014-4000mm	Sliding Track For SWSF 014	ALU
				BL

SR.	IMAGE	ITEM CODE	DESCRIPTION	PER
30		SWSF 015	Sliding Fitting For Wooden Door-bothside Soft Close. Door Thickness 30-50mm. Minimum Door Width 500mm. Per Panel Weight Capacity 80kgs. Door Height Up To 3000mm. Suitable Track: SST 015	SET
31		SWSF 015	Glass Sliding Fitting	SET
		SGSF 011P	SS 304 Patch For Sliding Roller (1 Door Kit)	SET
		SGSF 015	Both Side Soft Close Sliding System Glass Thickness 10/12mm. Minimum Door Width 500mm. Per Panel Weight Capacity 80kgs. Door Height Up To 3000mm. Suitable Track: SST 015	SET
32		SST 015-2440mm	Sliding Track For SWSF 015	ALU/BL CG/RG MB/PG
		SST 015-3660mm	Sliding Track For SWSF 015	ALU/BL CG/RG MB/PG
33		SWSF 016	Sliding Fitting For Wooden Door-bothside Soft Close. Door Thickness 30-50mm. Minimum Door Width 600mm. Per Panel Weight Capacity-120kgs. Door Height Up To 3000mm. Suitable Track: SST 016	SET
34		SWSF 016	Glass Sliding Fitting	SET
		SGSF 011P	SS 304 Patch For Sliding Roller (1 Door Kit)	SET
		SGSF 016	Both Side Soft Close Sliding System Glass Thickness 10/12mm. Minimum Door Width 500mm. Per Panel Weight Capacity 120kgs. Door Height Up To 3000mm. Suitable Track: SST 016	SET
35		SST 016-2440mm	Sliding Track For SWSF 016	ALU/BL CG/RG MB/PG
		SST 016-3660mm	Sliding Track For SWSF 016	ALU/BL CG/RG MB/PG
36		SGSF 017	<b>Floor guide</b>	PCS



## SR. 1 GLASS TELESCOPIC SLIDING FITTING (2+1)

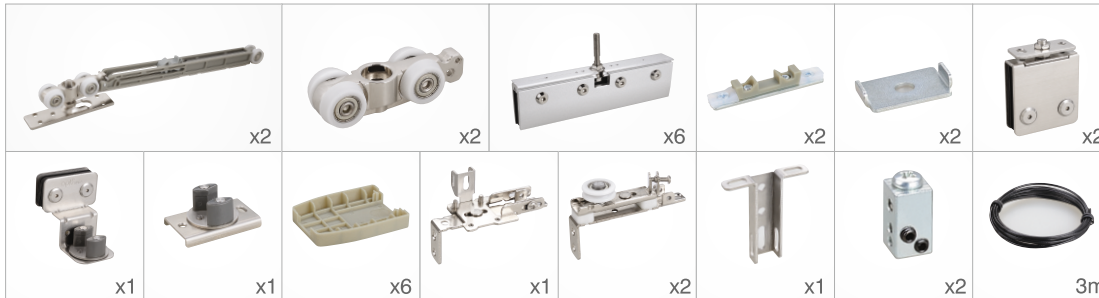

ITEM CODE	DESCRIPTION	ITEM
SGSF 017-2	Synchronized telescopic sliding system with soft close (2+1) Glass thickness 8-12mm. Per panel weight capacity 80kgs. Suitable Track: SST 017	2+1 Slider
		3 Tracks
		2 Cover
<b>Total For 2+1 Door Fitting, Tracks &amp; Cover Profile</b>		

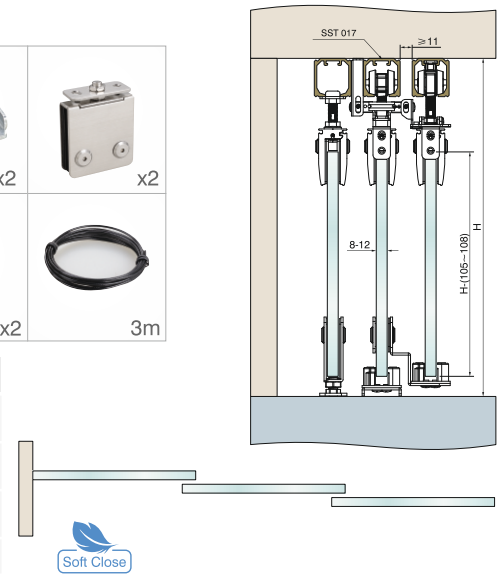

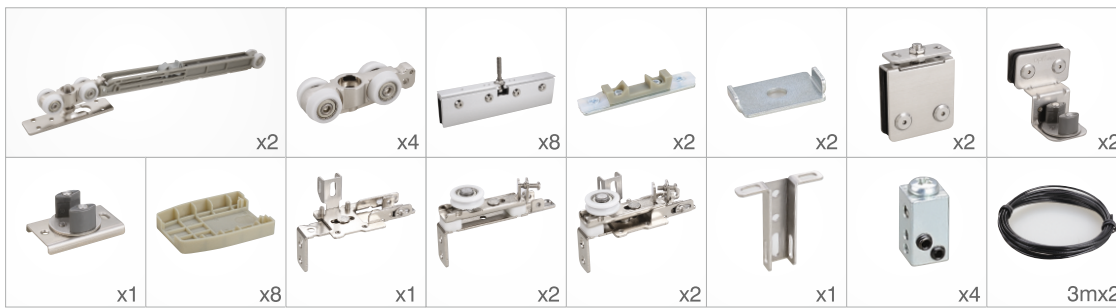

## SR. 2 GLASS TELESCOPIC SLIDING FITTING (3+1)



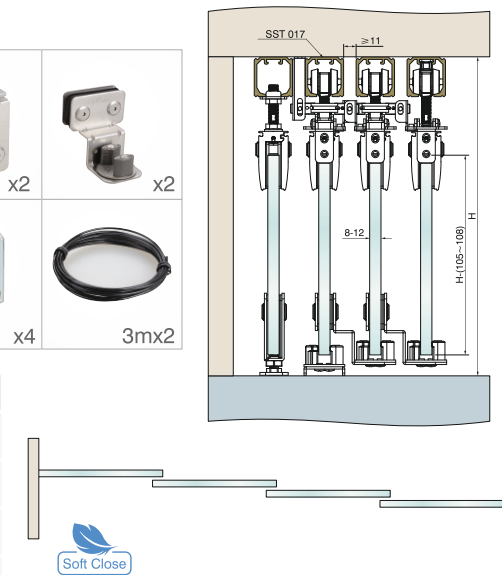



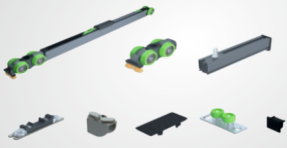

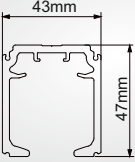
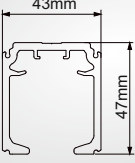
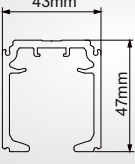
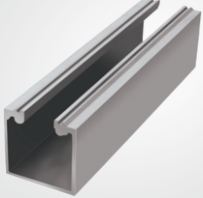
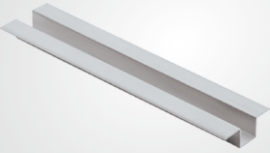





ITEM CODE	DESCRIPTION	ITEM
SGSF 017-3	Synchronized telescopic sliding system with soft close (3+ 1) Glass thickness 8-12mm. Per panel weight capacity 80kgs. Suitable Track: SST 017	3+1 Slider
		4 Tracks
		2 Cover
<b>Total For 3+1 Door Fitting, Tracks &amp; Cover Profile</b>		



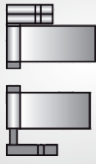
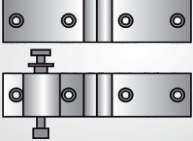
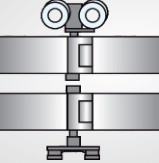

3		SST 017-4000mm	Sliding Track For SWSF 017 & SGSF 017	PCS
		SST 018-4000mm	Sliding Cover For SST 017	PCS

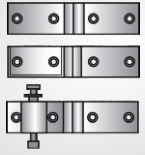
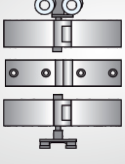
SR.	IMAGE	ITEM CODE	DESCRIPTION	PER	
1		SWSF 027	Wooden Door 160 kg 	SET	
2		SST 027	Door Track Track Suitable For SWSF027 2440MM	BL CG/RG MB/PG	
3		SST 027	Door Track Track Suitable For SWSF027 3660MM	BL CG/RG MB/PG	
4		SST 027	Door Track Track Suitable For SWSF027 4880MM	BL CG/RG MB/PG	
5		SST019-2440MM	Top Alluminium Profile	ALU/BL RG/CG MB/PG	
		SST019-3660MM	Top Alluminium Profile	ALU/BL RG/CG MB/PG	
		SST019-4880MM	Top Alluminium Profile	ALU/BL RG/CG MB/PG	
6		SST020-2440MM	Bottom Alluminium Profile	ALU/BL RG/CG MB/PG	
		SST020-3660MM	Bottom Alluminium Profile	ALU/BL RG/CG MB/PG	
		SST020 -4880MM	Bottom Alluminium Profile	ALU/BL RG/CG MB/PG	

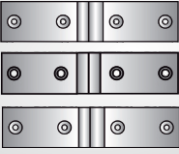
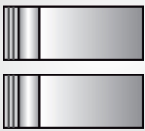







SR.	IMAGE	ITEM CODE	DESCRIPTION	PER	
1		SWSLDF 501P	Wooden Sliding Folding Top & Bottom Pivot	SET	
2		SWSLDF 501B	Wooden Sliding Folding Hinge With Handle. Finish: SSS.	SET	
3		SWSLDF 501C	Wooden Sliding Folding Intermediate Hanger Roller With Guide	SET	
4		SWSLDF 501D	Wooden Sliding Folding End Roller With Guide Roller	SET	
5		SWSLDF 501 BH	Wooden Sliding Folding Extra Hinges	PCS	
6		SWSLDF 501 H	Wooden Sliding Folding Hinges Set of 3 pcs.	SET	
7		SWSLDF 601R	Wooden Center Sliding Folding Fitting With Bottom Guide Weight Capacity 100 Kgs/door Suitable Track: SST 006	SET	
8		SWSF 018	Wooden Sliding Fitting For 1 door Suitable For SST016 Weight Capacity 80kg	SET	
9		SWSF 018A	Wooden Sliding Fitting For 1 door Suitable For SST015 Weight Capacity 80kg	SET	









SR.	IMAGE	ITEM CODE	DESCRIPTION	PER	
1		SGSLDF 501P	Glass Sliding Folding Top & Bottom Pivot	SET	
2		SGSLDF 501B	Glass Sliding Folding Glass To Glass Connected With Stopper	SET	
3		SGSLDF 501C	Glass Sliding Folding Intermediate Hanger Roller With Guide	SET	
4		SGSLDF 501D	Glass Sliding Folding End Roller With Guide Roller	SET	
5		SGSLDF 511B	Glass Sliding Folding Glass To Glass Connected With Stopper	PCS	
6		SGSLDE 511C	Glass Sliding Folding Intermediate Hanger Roller With Guide	SET	
7		SGSLDF 501E	Glass Sliding Folding Handle (Optional)	SET	
8		SGSLDF 501BH	Glass Sliding Folding Glass To Glass Connector Without Stopper (1 Set = 3 Pcs)	SET	
9		SGSLDF 501H	Glass Sliding Folding Wall To Glass Connected Hinge	SET	

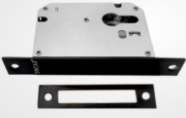

SR.	IMAGE	ITEM CODE	DESCRIPTION	PER	
10		SGSLDF 501S	Glass Sliding Folding Extra Stopper	PCS	
11		SGSLDF 551H	Glass Sliding Folding Wall To Glass Connected Hinge	SET	
12		SGSLDF601R	Glass Center Sliding Folding Roller With Patch	PCS	
13		SGSLDF-601B	Glass Center Sliding Folding Glass To Glass Hinges	PCS	
14		SGSLDF 601H	Glass Center Sliding Folding Wall To Glass Hinges	PCS	
15		SGSLDE 601 L	Glass centre sliding folding lock	PCS	
16		SGSLDF 601F	Bottom floor bush	PCS	

SR.	IMAGE	ITEM CODE	DESCRIPTION	PER	
1		SDC 1101 SILVER	Open Door Closer 45-60 Kg EN-3	PCS	
2		SDC 1102 SILVER	Open Door Closer Triangle 40-65 Kg EN-3 Silver	PCS	
3		SDC 1103	Surface Mounted Hold Open Pelmet Arm Door Closer EN-3 80Kg Per Pcs	SILVER	
				BLACK	
				CG/RG	
				MB/PG	
4		SDC 1103 ACG	Aluminium Clamp For Glass Door Per Pcs	SILVER	
				BLACK	
				CG/RG	
				MB/PG	
5		SDC 1105	Surface Mounted Hold Open Pelmet Arm Door Closer Black EN-2-4 120Kg	SILVER	
				BLACK	
				CG/RG	
				MB/PG	
6		SCDC 001 BLACK	Rack And Pinion Concealed Door Closer, Adjustable Closing And Latching Speed , EN-3 , Max Door Weight 60 Kg Black Finish	PCS	
7		SCDC 002 BLACK	Rack And Pinion Concealed Door Closer, Adjustable Closing And Latching Speed, En 2-4, Max Door Weight 100 Kg, Black Finish	PCS	
8		SCDC 003 BLACK	Cam Action Concealed Door Closer, Adjustable Closing And Latching Speed, En 2-4, Max Door Weight 120 Kg Black Finish	PCS	

SR.	IMAGE	ITEM CODE	DESCRIPTION	PER	
9		SFS 1001	80KG Single Spring Floor Spring With SS304 Max Door Width: 950MM	SS	
				BL	
				CG/RG	
				MB/PG	
10		SFS 1002	120kg Double Spring Floor Spring With SS304 Platemax Door Width: 800mm En-2	SS	
				BL	
				CG/RG	
				MB/PG	
11		SFS 1003	120kg Double Spring Floor Spring With SS304 Platemax Door Width: 950mm En-3	SS	
				BL	
				CG/RG	
				MB/PG	
13		SFS 1004	120kg Double Spring Floor Spring With Ss304 Platemax Door Width: 1150mm En-4	SS	
				BL	
				CG/RG	
				MB/PG	
14		SFS 1005	150kg Compact Mode Double Spring Floor Spring With SS304 Platemax Door Width: 750mm-1150mm En 2-4	SS	
				BL	
				CG/RG	
				MB/PG	
15		SFS 1006	Hydraulic Pivot For Wooden Door 80 Kg Weight Capacity Door Width Could Be 950mm	PCS	
16		SFS 1007	Hydraulic Patch For Glass Door 100 Kg Weight Capacity Door Width Could Be 1000mm	PCS	
17		SFS ACC 001	Wooden Door Top Bottom Pivot	SET	

SR.	IMAGE	ITEM CODE	DESCRIPTION	PER	
1		SPF801SS	Top Patch For Glass Door SS Finish	PCS	
2		SPF801BL	Top Patch For Glass Door BLACK Finish	PCS	
3		SPF802SS	Bottom Patch For Glass Door SS Finish	PCS	
4		SPF802BL	Bottom Patch For Glass Door BLACK Finish	PCS	
5		SPF803SS	Pivot For Glass Door SS Finish	PCS	
6		SPF803BL	Pivot For Glass Door BLACK Finish	PCS	
7		SPF804SS	Bottom Lock For Glass Door SS Finish	PCS	
8		SPF804BL	Bottom Lock For Glass Door BLACK Finish	PCS	

SR.	IMAGE	ITEM CODE	DESCRIPTION	PER	
1		SDL 001	Cy Dead Lock 50mm	SET	
2		SDL 002	Icy Deadl Lock 25mm/30mm	SS/BL	
				CG/RG	
				MB/PG	
3		SDLACC 001	CY Key Holl Ovel	SS/BL	
				CG/RG	
				MB/PG	
4		SMB 2025	25mm Mortise Lock Body	SS/BL	
				CG/RG	
				MB/PG	
5		SMH 001	Mortise Handle Black Matt Finish	SS/BL	
				CG/RG	
				MB/PG	
6		SCY 3060	60mm Cylinder KXN Black Matt	SS/BL	
				CG/RG	
				MB/PG	
		SCY 3070	70mm Cylinder KXN Black Matt	SS/BL	
				CG/RG	
				MB/PG	
7		SDS 001	Door Straightener Size: 1950mm	SET	
8		SDDS001-750 SDDS001-900 SDDS001-1050 SDDS001-1200	Drop Down Seal	750mm	
				900mm	
				1050mm	
				1200mm	

SR.	IMAGE	ITEM CODE	DESCRIPTION	PER
9		SGDH-001	Glass Door Q Handle 22X300	SS BL CG/RG MB/PG
			Glass Door Q Handle 22X450	SS BL CG/RG MB/PG
			Glass Door Q Handle 25X600	SS BL CG/RG MB/PG
			Glass Door Q Handle 25X750	SS BL CG/RG MB/PG
10		SGDH-002	Glass Door D Handle 22X300	SS BL CG/RG MB/PG
			Glass Door D Handle 22X450	SS BL CG/RG MB/PG
			Glass Door D Handle 25X600	SS BL CG/RG MB/PG
			Glass Door D Handle 25X750	SS BL CG/RG MB/PG
11		SGDH-003	Glass Door H Handle 22X300	SS BL CG/RG MB/PG
			Glass Door H Handle 22X450	SS BL CG/RG MB/PG
			Glass Door H Handle 25X600	SS BL CG/RG MB/PG
			Glass Door H Handle 25X750	SS BL CG/RG MB/PG

SR.	IMAGE	ITEM CODE	DESCRIPTION	PER	
12		SGDH-004	Glass Door Handle With Lock 35x1500	SS	
				BL	
				CG/RG	
				MB/PG	



## GUJARAT DECOR PVT. LTD.

### SURAT

8-9, Mahavir Small Industrial Estate,  
Bamroli-Vadod Road,  
Vadod Gam, Surat,  
Gujarat. India - 394 221



### CHANDIGARH

Nabha Sahib. Shop No 1.  
Jagait Complex, High Ground Road,  
Nabha Zirakpur Sas Nagar,  
Chandigarh, Punjab - 140 603



### PATNA

Ward No. 54Maurya Colony,  
Behind Shiv Mandir,  
East of BISCOMAN Colony,  
PS Alamganj, Dist. Patna



Customer Care :  + 91 98989 90003

 [hello@socarhardware.com](mailto:hello@socarhardware.com)

 [www.socarhardware.com](http://www.socarhardware.com)



  
facebook



  
website



  
instagram



  
youtube



  
catalogue

### Legal Disclaimer

Whilst every effort has been made to ensure that the information contained in this brochure is accurate at the time of publication, SOCAR recommends that you consult SOCAR, its authorised distributors and dialers prior to placing an order to ascertain current information on specific product, as SOCAR reserves the right to make changes without prior notice. SOCAR will not be liable for any errors or omissions in the information contained in the brochure or arising from the use or application of the information contained herein. This brochure does not constitute an offer for the sale of any particular product.