

SOCAR[®]

Innovative Hardware Solution

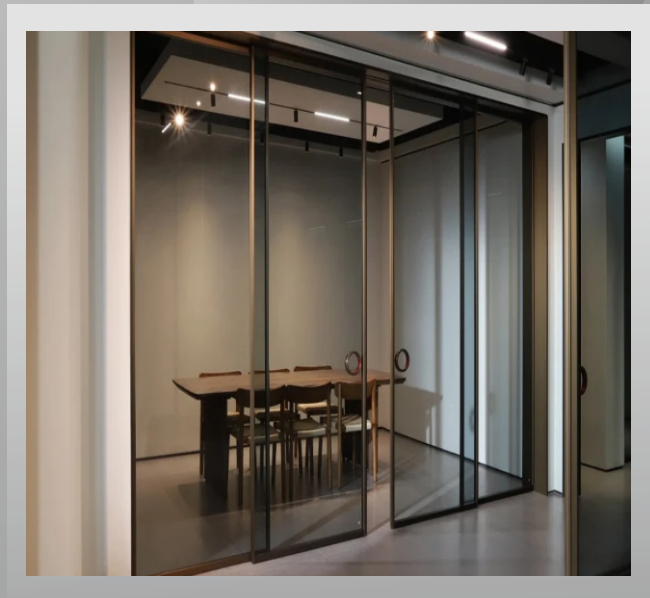

SOCAR[®]

Innovative Hardware Solution



SOCAR is an effort to provide you with the latest, trendy & innovative hardware solutions that give your furniture a touch of luxury. We are committed to serve your interior needs with products that go in hand with the european standards. We are a growing company that constantly thrives on contemporary ideas of modern interior solutions.





/ INDEX	NO
SLIDING WARDROBE SYSTEM	5
ORCA	
ORBIT	
DECK	
AREO	
ZEOH	
OPENABLE WARDROBE	13
RECAN	
CAPELLO	
INCLINO	
CORSA	
PALLADIO	
HORIZON	
CORNELLA	
REGOR	
POLARIS	
NEBULA	
TROMES	
ANTLIA	
COLUMBA	
CYGNUS	
DORADO	
TRUMP	
VERTICO	
OPEN WARDROBE/SELVING SYSTEM	31
BASTIA	
NORD	
LUMINO	
CUBO	
ALLY	
SHOE SELF PROFILE - LIPIN	
SLIDING FOLDING PARTATION	39
FREE FOLD	
BARBENO	
WARDROBE ACCESSORES	45
PANELING PROFILE	48
12MM DADD SERIES SAME AS OLD	
18MM DADD SERIES	
TELESCOPIC SLIDING / SYANCHRO	52
PERFECT	
TARVOS	
CUBOID	
DECO	
PRISM	
ESILE	
CURVO	
PERK	
BELIMOS	
MAGNETIC AUTOMATIC TELESCOPIC SLIDING	
AUTOMATIC SENSOR DOOR SYANCHRO SLIDING	
SWING DOOR	64
TRAVOS	
PERFECT	
WASHROOM GLASS CUBICAL	92
ORRA	
MIST	
REDDIK	
ENTO	
SLIM	
FRAME PROFILE	101
KITCHEN PROFILE GOLA PROFILE	103
KITCHEN HANDLE PROFILE	104
EDGE PROFILES	105

Sliding Wardrobe

The continuous rise in the space saving solutions lead our way to the sliding wardrobes where you get more storage in limited space.







ORCA SLIDING WARDROBE SYSTEM

SAP-196

BLACK	3637/-
RG/CG	3856/-
MB/PG	4068/-

1 LENGTH: 3 MTR

SAP-197

BLACK	2326/-
RG/CG	2466/-
MB/PG	2602/-

1 LENGTH: 3 MTR

SAP-198

BLACK	4003/-
RG/CG	4243/-
MB/PG	4476/-

1 LENGTH: 3 MTR

SAP-199

BLACK	2785/-
RG/CG	2952/-
MB/PG	3115/-

1 LENGTH: 3 MTR

SSA-018

UNIT: 1 PCS	50/-
-------------	------

SGP-2001

UNIT: METER	65/-
-------------	------

SWSF-030

UNIT: 1 SET	4040/-
-------------	--------

SST-030

	2440 MM	3660 MM
BLACK	7315/-	10057/-
RG/CG	7681/-	10560/-
MB/PG	8295/-	11405/-

1 LENGTH

SGP-2002

UNIT: METER	52/-
-------------	------



Available in Premium Finishes.



ORBIT SLIDING WARDROBE SYSTEM

SAP-194		
	BLACK	4221/-
	RG/CG	4474/-
	MB/PG	4720/-
1 LENGTH: 3 MTR		

SAP-197		
	BLACK	2326/-
	RG/CG	2466/-
	MB/PG	2602/-
1 LENGTH: 3 MTR		

SAP-198		
	BLACK	4003/-
	RG/CG	4243/-
	MB/PG	4470/-
1 LENGTH: 3 MTR		

SAP-199		
	BLACK	2785/-
	RG/CG	2952/-
	MB/PG	3115/-
1 LENGTH: 3 MTR		

SSA-018		
UNIT: 1 PCS	50/-	

SGP-2001		
UNIT: MTR.	65/-	

SWSF-030		
UNIT: 1 SET	4040/-	

SST-030			
	2440 MM	3660 MM	
	BLACK	7315/-	10,057/-
	RG/CG	7681/-	10,560/-
1 LENGTH	MB/PG	8295/-	11,405/-

SGP-2002 (STICK ON GASKET)		
UNIT: MTR.	52/-	



Available in Premium Finishes.



DECK SLIDING WARDROBE SYSTEM

SAP-195

BLACK	5488/-
RG/CG	5818/-
MB/PG	6138/-

1 LENGTH: 3 MTR

SAP-193

BLACK	5948/-
RG/CG	6305/-
MB/PG	6651/-

1 LENGTH: 3 MTR

SAP-198

BLACK	4003/-
RG/CG	4243/-
MB/PG	4476/-

1 LENGTH: 3 MTR

SAP-199

BLACK	2785/-
RG/CG	2952/-
MB/PG	3115/-

1 LENGTH: 3 MTR

SAP-197

BLACK	2326/-
RG/CG	2466/-
MB/PG	2602/-

1 LENGTH: 3 MTR

SGP-2001

UNIT: MTR.	65/-
------------	------

SSA-018

UNIT: 1 PCS	50/-
-------------	------

SWSF-030

UNIT: 1 SET	4040/-
-------------	--------

SST-030

BLACK	7315/-	10,057/-
RG/CG	7681/-	10,560/-
MB/PG	8295/-	11,405/-

1 LENGTH

SGP-2002 (STICK ON GASKET)

UNIT: MTR.	52/-
------------	------



Available in Premium Finishes.



AREO SLIDING WARDROBE SYSTEM

SAP-293(BOTTOM PROFILE)

	BLACK	4510/-
	RG/CG	4780/-
	MB/PG	5043/-
1 LENGTH: 3 MTR		

SAP-290(HANDLE PROFILE)

	BLACK	3823/-
	RG/CG	4052/-
	MB/PG	4275/-
1 LENGTH: 3 MTR		

SAP-292(DIVIDER PROFILE)

	BLACK	2888/-
	RG/CG	3062/-
	MB/PG	3230/-
1 LENGTH: 3 MTR		

SAP-291(TOP PROFILE)

	BLACK	3502/-
	RG/CG	3712/-
	MB/PG	3916/-
1 LENGTH: 3 MTR		

SSA-018



UNIT: 1 PCS	50/-
-------------	------

SGP-2001



UNIT: MTR.	65/-
------------	------

SWSF-030



UNIT: 1 SET	4040/-
-------------	--------

SST-030

	2440 MM	3660 MM	
	BLACK	7315/-	10057/-
	RG/CG	7681/-	10560/-
1 LENGTH	MB/PG	8295/-	11405/-

SPCA-290



UNIT: SET (4 PCS)	600/-
-------------------	-------

SPCA-292

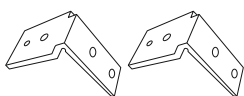

UNIT: SET (2 PCS)	450/-
-------------------	-------

SGP-2002 (STICK ON GASKET)



UNIT: MTR.	52/-
------------	------



MOCHA BROWN



CLASSIC GOLD



ROSE GOLD



CERAMIC BLACK



PORCELAIN GREY

Available in Premium Finishes.



ZEOH SLIDING WARDROBE SYSTEM

SAP-289 (BOTTOM PROFILE)

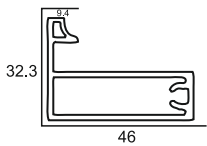

BLACK	4667/-
RG/CG	4947/-
MB/PG	5219/-

1 LENGTH: 3 MTR

SAP-287 (TOP PROFILE)

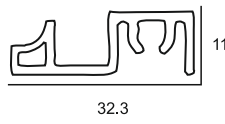

BLACK	2543/-
RG/CG	2696/-
MB/PG	2844/-

1 LENGTH: 3 MTR

SAP-288 (DIVIDER PROFILE)

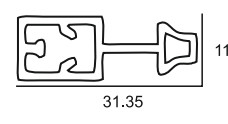

BLACK	2513/-
RG/CG	2664/-
MB/PG	2810/-

1 LENGTH: 3 MTR

SAP-286 (HANDLE PROFILE)

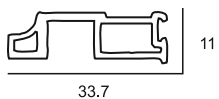

BLACK	2549/-
RG/CG	2702/-
MB/PG	2851/-

1 LENGTH: 3 MTR

SSA-018



UNIT: 1 PCS

50/-

SGP-2001

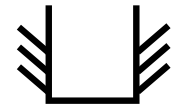

UNIT: MTR.

65/-

SWSF-030



UNIT: 1 SET

4040/-

SST-030

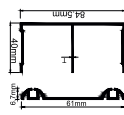

	2440 MM	3660 MM
BLACK	7315/-	10,057/-
RG/CG	7681/-	10,560/-
MB/PG	8295/-	11,405/-

1 LENGTH

SGP-2002 (STICK ON GASKET)



UNIT: MTR.

52/-



MOCHA BROWN



CLASSIC GOLD



ROSE GOLD



CERAMIC BLACK



PORCELAIN GREY

Available in Premium Finishes.

SLIDING WARDROBE SYSTEM



SOCAR[®]

Innovative Hardware Solution

Openable Wardrobe

The Unique Craftsmanship In The Designs Transform Into Luxury With The Openable Wardrobes Where You Get Multiple Colour Choices To Enhance Your Spaces.







RECAN OPENABLE WARDROBE

SAP-101 (45MM FRAME PROFILE)

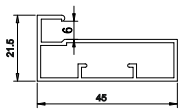

1 LENGTH: 3 MTR

BLACK	3038/-
RG/CG	3220/-
MB/PG	3397/-

SAP-104 (1200MM CNC HANDLE PROFILE L & R)

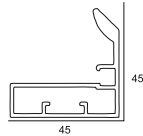

1 LENGTH: 3 MTR

BLACK	6015/-
RG/CG	6376/-
MB/PG	6727/-

SPCA-116



1 Set

159/-

SAH CL 111 BLACK



Unit: 1 Set

0 Crank	484/-
8 Crank	498/-
16 Crank	512/-

SAH CL 161 BLACK



Unit: 1 Set

3D Adjustable

0 Crank	410/-
8 Crank	422/-
16 Crank	432/-



MOCHA BROWN



CLASSIC GOLD



ROSE GOLD



CERAMIC BLACK



PORCELAIN GREY

Available in Premium Finishes.



CAPELLO OPENABLE WARDROBE

SAP-177 (FRAME)

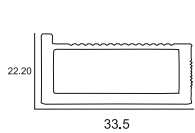

1 LENGTH: 3 MTR

BLACK	4453/-
RG/CG	4720/-
MB/PG	4980/-

SAP-176 (1200MM CNC HANDLE)

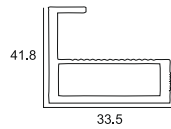

1 LENGTH: 3 MTR

BLACK	6676/-
RG/CG	7077/-
MB/PG	7466/-

SPCA-176



UNIT: 1 SET (4 PCS)

159/-

SPCA-177



UNIT: 1 SET (4 PCS)

1390/-

SCPH-001



UNIT: 1 SET

8841/-



MOCHA BROWN



CLASSIC GOLD



ROSE GOLD



CERAMIC BLACK



PORCELAIN GREY

Available in Premium Finishes.

CORSA OPENABLE WARDROBE



SAP-247

BLACK	5499/-
MB/PG	5775/-

1 LENGTH: 3 MTR

SAP-248

BLACK	4282/-
MB/PG	4496/-

1 LENGTH: 3 MTR

SAP-249

BLACK	3377/-
MB/PG	3545/-

1 LENGTH: 3 MTR

INCLINO OPENABLE WARDROBE



SAP-178

BLACK	5285/-
RG/CG	5602/-
MB/PG	5910/-

1 LENGTH: 3 MTR

SAP-179

BLACK	3260/-
RG/CG	3455/-
MB/PG	3645/-

1 LENGTH: 3 MTR

SAP-200

BLACK	2947/-
RG/CG	3124/-
MB/PG	3296/-

1 LENGTH: 3 MTR

SAP-180

	200MM	300MM	600MM	1200
CG	1314/-	1680/-	2035/-	2514/-
BL	1240/-	1585/-	1920/-	2370/-
MB	1387/-	1773/-	2147/-	2650/-

1 LENGTH: 3 MTR

SAH CL 111 BLACK

0 CRANK	484/-
8 CRANK	498/-
16 CRANK	512/-

UNIT: 1 SET

SAH CL 151

0 CRANK	335/-
8 CRANK	346/-
16 CRANK	356/-

UNIT: 1 SET

SAP-219

BLACK	1620/-
RG/CG	1717/-
MB/PG	1811/-

1 LENGTH: 3 MTR

- MOCHA BROWN
- CLASSIC GOLD
- ROSE GOLD
- CERAMIC BLACK
- PORCELAIN GREY

Available in Premium Finishes.

PALLADIO OPENABLE WARDROBE



SAP-275		
	BLACK	2795/-
	RG/CG	2963/-
	MB/PG	3126/-
1 LENGTH: 3 MTR		

SAP-276 (200/1200MM CNC HANDLE)		
	BLACK	4710/-
	RG/CG	4992/-
	MB/PG	5267/-
1 LENGTH: 3 MTR		

KUBODE OPENABLE WARDROBE



SAP-275		
	BLACK	2795/-
	RG/CG	2963/-
	MB/PG	3126/-
1 LENGTH: 3 MTR		

SAP-277 (200/1200MM CNC HANDLE)		
	BLACK	5481/-
	RG/CG	5810/-
	MB/PG	6130/-
1 LENGTH: 3 MTR		

HEBREW OPENABLE WARDROBE



SAP-275		
	BLACK	2795/-
	RG/CG	2963/-
	MB/PG	3126/-
1 LENGTH: 3 MTR		

SAP-278		
	BLACK	3869/-
	RG/CG	4101/-
	MB/PG	4326/-
1 LENGTH: 3 MTR		

SPCA CL 130 (3D ADJUSTABLE)		
	0 CRANK	710/-
	8 CRANK	724/-
	16 CRANK	735/-
UNIT: 1 SET		

SPCA-275	
UNIT: 1 SET	450/-



HORIZON OPENABLE WARDROBE



SAP-275 (200MM CNC FRAME)		
 1 LENGTH: 3 MTR	BLACK	2795/-
	RG/CG	2963/-
	MB/PG	3126/-

SAP-279		
 1 LENGTH: 600 MM	BLACK	2078/-
	RG/CG	2203/-
	MB/PG	2324/-

INLEY OPENABLE WARDROBE



SAP-275 (200MM CNC FRAME)		
 1 LENGTH: 3 MTR	BLACK	2795/-
	RG/CG	2963/-
	MB/PG	3126/-

SAP-280		
 1 LENGTH: 600 MM	BLACK	1776/-
	RG/CG	1883/-
	MB/PG	1986/-

SPCA CL 130 (3D ADJUSTABLE)		
 UNIT: 1 SET	0 CRANK	710/-
	8 CRANK	724/-
	16 CRANK	735/-

SPCA-275		
 UNIT: 1 SET	450/-	

SPCA-279		
 UNIT:PCS	50/-	

SPCA-280		
 UNIT:PCS	65/-	

- MOCHA BROWN
- CLASSIC GOLD
- ROSE GOLD
- CERAMIC BLACK
- PORCELAIN GREY

Available in Premium Finishes.



CORNELLA OPENABLE WARDROBE



SAP-181 (FRAME)		
<p>1 LENGTH: 3 MTR</p>	BLACK	4712/-
	RG/CG	4995/-
	MB/PG	5270/-

SAP-183 (1200MM CNC HANDLE)		
<p>1 LENGTH: 3 MTR</p>	BLACK	7792/-
	RG/CG	8259/-
	MB/PG	8713/-

REGOR OPENABLE WARDROBE



SAP-181 (FRAME)		
<p>1 LENGTH: 3 MTR</p>	BLACK	4712/-
	RG/CG	4995/-
	MB/PG	5270/-

SAP-182 (1200MM CNC HANDLE)		
<p>1 LENGTH: 3 MTR</p>	BLACK	7285/-
	RG/CG	7722/-
	MB/PG	8147/-

POLARIS OPENABLE WARDROBE



SAP-184 (FRAME)		
<p>1 LENGTH: 3 MTR</p>	BLACK	3428/-
	RG/CG	3634/-
	MB/PG	3834/-

SAP-185 (200/1200MM CNC HANDLE)		
<p>1 LENGTH: 3 MTR</p>	BLACK	5989/-
	RG/CG	6348/-
	MB/PG	6698/-

SPCA-116	
	159/-
1 Set	

SPCA CL 130 (3D ADJUSTABLE)		
<p>UNIT: 1 SET</p>	0 CRANK	710/-
	8 CRANK	724/-
	16 CRANK	735/-

SPCA-177	
	1390/-
UNIT: 1 SET	

SPPH-001	
	8841/-
UNIT: 1 SET	



Available in Premium Finishes.



NEBULA OPENABLE WARDROBE

SAP-211 (FRAME)

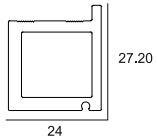

BLACK	4882/-
RG/CG	5175/-
MB/PG	5460/-

1 LENGTH: 3 MTR

SAP-212 (200/1200MM CNC HANDLE)

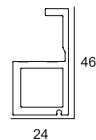

BLACK	7777/-
RG/CG	8244/-
MB/PG	8697/-

1 LENGTH: 3 MTR

SCPH-002



UNIT: 1 SET

18861/-

SPCA-211



UNIT: 1 SET (4 PCS)

1880/-



MOCHA BROWN



CLASSIC GOLD



ROSE GOLD



CERAMIC BLACK



PORCELAIN GREY

Available in Premium Finishes.



TROMES OPENABLE WARDROBE



SAP-285 (HANDALE PROFILE)

<p>1 LENGTH: 3 MTR</p>	BLACK	6805/-
	RG/CG	7213/-
	MB/PG	7603/-

SAP-284 (FRAME PROFILE)

<p>1 LENGTH: 3 MTR</p>	BLACK	5155/-
	RG/CG	5464/-
	MB/PG	5765/-

SPCA-211



UNIT: 1 SET (4 PCS) 1880/-

SCPH-002



UNIT: 1 SET 18861/-



MOCHA BROWN



CLASSIC GOLD



ROSE GOLD



CERAMIC BLACK



PORCELAIN GREY

Available in Premium Finishes.



ANTLIA OPENABLE WARDROBE



SAP-250 (FRAME)

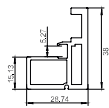

BLACK	11,910/-
RG/CG	13,190/-
MB/PG	13,190/-

1 LENGTH: 3.MTR

SAP-251 (HANDLE)

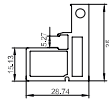

BLACK	14,193/-
RG/CG	16,693/-
MB/PG	16,693/-

1 LENGTH: 3.MTR

SPCA-251 (CONNECTOR)



UNIT: 1 SET (4 PCS)

142/-

SAP-252 (FRAME)

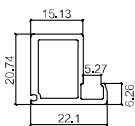

BLACK	4374/-
RG/CG	4810/-
MB/PG	4810/-

1 LENGTH: 3.MTR

SCPH-003



UNIT: 1 SET

9915/-



MOCHA BROWN



CLASSIC GOLD



ROSE GOLD



CERAMIC BLACK



PORCELAIN GREY

Available in Premium Finishes.



SAP-186 (Frame)	
	Unit: 1 Length
	1 Length: 3 Mtr
	Black Matt 3947/-
	Brush Gold 4184/-
	Rose Gold 4414/-

SAP-187 (1200mm CNC Handle)	
	Unit: 1 Length
	1 Length: 3 Mtr
	Black Matt 6285/-
	Brush Gold 6662/-
	Rose Gold 7028/-

SPCA-116	
1 Set	159/-

SAH CL 111 BLACK	
	Unit: 1 Set
	0 Crank 484/-
	8 Crank 498/-
	16 Crank 512/-

SAH CL 161 BLACK	
	Unit: 1 Set
	3D Adjustable
	0 Crank 410/-
	8 Crank 422/-
	16 Crank 432/-

MOCHA BROWN

CLASSIC GOLD

ROSE GOLD

CERAMIC BLACK



PORCELAIN GREY

Available in Premium Finishes.

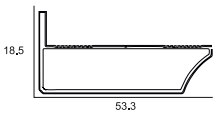

CYGNUS OPENABLE WARDROBE

SAP-223



1 LENGTH: 3.MTR

BLACK	3285/-
RG/CG	3482/-
MB/PG	3673/-

SAP-224

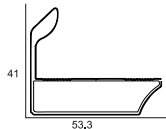

1 LENGTH: 3.MTR

BLACK	6488/-
RG/CG	6878/-
MB/PG	7256/-

SPCA-119



UNIT: 1 SET (4 PCS)

190/-

SAH CL 111 BLACK



UNIT: 1 SET

0 CRANK	484/-
8 CRANK	498/-
16 CRANK	512/-

SAH CL 151



UNIT: 1 SET

0 CRANK	335/-
8 CRANK	346/-
16 CRANK	356/-



MOCHA BROWN



CLASSIC GOLD



ROSE GOLD



CERAMIC BLACK



PORCELAIN GREY

Available in Premium Finishes.



DORADO OPENABLE WARDROBE

SAP-264 FOR 18MM

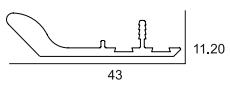

BLACK	4517/-
RG/CG	4788/-
MB/PG	5051/-

1 LENGTH: 3MTR

SAP-265

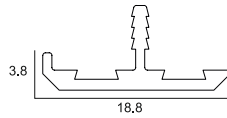

BLACK	1232/-
RG/CG	1305/-
MB/PG	1377/-

1 LENGTH: 3MTR

SPCA-264



UNIT:PCS

60/-

SAP-365 FOR 25MM

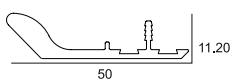

BLACK	4734/-
RG/CG	5018/-
MB/PG	5294/-

1 LENGTH: 3MTR

SAP-365

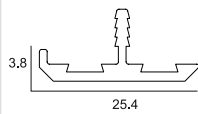

BLACK	1442/-
RG/CG	1529/-
MB/PG	1613/-

1 LENGTH: 3MTR

SPCA-364



UNIT:PCS

60/-



MOCHA BROWN



CLASSIC GOLD



ROSE GOLD



CERAMIC BLACK



PORCELAIN GREY

Available in Premium Finishes.



SAP-220 FOR 18MM

BLACK	4566/-
RG/CG	4840/-
MB/PG	5106/-

1 LENGTH: 3 MTR

SAP-222 FOR 18MM

BLACK	4747/-
RG/CG	5032/-
MB/PG	5309/-

1 LENGTH: 3 MTR

SAP-221 FOR 25MM

BLACK	5247/-
RG/CG	5556/-
MB/PG	5868/-

1 LENGTH: 3 MTR



MOCHA BROWN



CLASSIC GOLD



ROSE GOLD



CERAMIC BLACK



PORCELAIN GREY

Available in Premium Finishes.



VERTICO OPENABLE WARDROBE

SAP-267

BLACK	2453/-
RG/CG	2600/-
MB/PG	2743/-

1 LENGTH: 3 MTR

SAP-268

BLACK	1910/-
RG/CG	2025/-
MB/PG	2136/-

1 LENGTH: 3 MTR

SAP-367

BLACK	2976/-
RG/CG	3155/-
MB/PG	3328/-

1 LENGTH: 3 MTR

SAP-368

BLACK	3079/-
RG/CG	3263/-
MB/PG	3443/-

1 LENGTH: 3 MTR

SAP-144

BLACK	3086/-
RG/CG	3271/-
MB/PG	3451/-

1 LENGTH: 3 MTR

SAP-145

BLACK	2206/-
RG/CG	2338/-
MB/PG	2467/-

1 LENGTH: 3 MTR

SAP-167

BLACK	3134/-
RG/CG	3322/-
MB/PG	3505/-

1 LENGTH: 3 MTR

SAP-168

BLACK	2224/-
RG/CG	2357/-
MB/PG	2487/-

1 LENGTH: 3 MTR

SPCA-367

END CAP L/R FOR SAP 367

BLACK	160/-
RG/CG	160/-
MB/PG	160/-

SPCA-368

END CAP L/R FOR SAP 368

BLACK	140/-
RG/CG	140/-
MB/PG	140/-



Available in Premium Finishes.

Poling & Shelving System

Aesthetics go in tandem with smart way of organising in our poling & shelving system. Generates architectural appeal & optimum level of opulence.







BASTIA POLING & SHELVING



SAP-239

BLACK	9147/-
MB/PG	9605/-

1 LENGTH: 3.5 MTR

SAP-240

BLACK	3716/-
MB/PG	3900/-

1 LENGTH: 3.5 MTR

SAP-241

BLACK	23,640/-
MB/PG	24822/-

1 LENGTH: 3.5 MTR

SAP-242 (L/R) 450 MM

BLACK	2000/-
MB/PG	2000/-

UNIT : PCS

SPCA-241-A (BASE OF UP RIGHT)

UNIT : PCS	7075/-
------------	--------

SPCA-241-B (FIXED ACCESSORIES)

UNIT : PCS	2010/-
------------	--------

SPCA-241-C (CONNECTOR)

UNIT: 1 SET (4 PCS)	48/-
---------------------	------

SDP 002 DIFFUSER (3000MM)

UNIT:PCS	280/-
----------	-------

SPCA-241-E (FOR WOODEN DRAWER)

UNIT:1 SET (2 PCS)	1050/-
--------------------	--------

SPCA-241-D (FOR WOODEN DRAWER)

UNIT:1 SET (2 PCS)	850/-
--------------------	-------



Available in Premium Finishes.



SAP-243

BLACK	9937/-
MB/PG	10,460/-

1 LENGTH: 3.5 MTR

SAP-244

BLACK	11,552/-
MB/PG	12,130/-

1 LENGTH: 3.5 MTR

SPCA-243

UNIT: 1 SET (4 PCS)	5228/-
---------------------	--------

SAP-245

BLACK	7491/-
MB/PG	7860/-

1 LENGTH: 3.5 MTR

SAP-246

BLACK	6244/-
MB/PG	6556/-

1 LENGTH: 3.5 MTR

SPA 281 OVER PIPE

BLACK	2669/-
RG/CG	2829/-
MB/PG	2984/-

SPCA-281

UNIT: PCS	450/-
-----------	-------

SRS-110

UNIT: METER	40/-
-------------	------

SPCA-217

UNIT: PCS	130/-
-----------	-------





LUMINO POLING & SHELVING

SAP-218

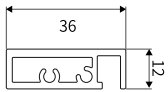

BLACK	3465/-
RG/CG	3673/-
MB/PG	3875/-

1 LENGTH: 3000

SAP-217

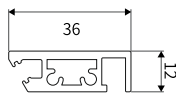

BLACK	3354/-
RG/CG	3555/-
MB/PG	3751/-

1 LENGTH: 3000

SPCA-217



UNIT:PCS

130/-

SDP 002 DIFFUSER (3000MM)



UNIT: PCS

280/-



MOCHA BROWN



CLASSIC GOLD



ROSE GOLD



CERAMIC BLACK



PORCELAIN GREY

Available in Premium Finishes.



CUBO POLING & SHELVING

SAP-228

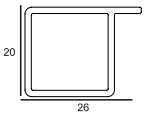

1 LENGTH: 3 MTR

BLACK	2373/-
RG/CG	2516/-
MB/PG	2654/-

SAP-228 A

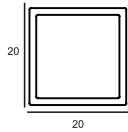

1 LENGTH: 3 MTR

BLACK	2259/-
RG/CG	2394/-
MB/PG	2526/-

SAP-229

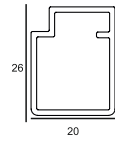

1 LENGTH: 3 MTR

BLACK	2452/-
RG/CG	2599/-
MB/PG	2742/-

SAP-230

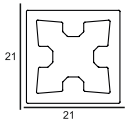

1 LENGTH: 3 MTR

BLACK	4489/-
RG/CG	4758/-
MB/PG	5020/-

SPCA-228



UNIT: 1 PCS

120/-

SPCA-229



UNIT: 1 PCS

210/-

SPCA-230 A



UNIT: 1 SET (2PCS)

130/-

SPCA-230



UNIT: 1 PCS

130/-



MOCHA BROWN



CLASSIC GOLD



ROSE GOLD



CERAMIC BLACK



PORCELAIN GREY

Available in Premium Finishes.



ALLY KITCHEN DRAWER FRAME

SAP-231

BLACK	3194/-
RG/CG	3386/-
MB/PG	3572/-

1 LENGTH: 3 MTR

SAP-232

BLACK	3839/-
RG/CG	4070/-
MB/PG	4294/-

1 LENGTH: 3 MTR

SAP-233

BLACK	2516/-
RG/CG	2666/-
MB/PG	2813/-

1 LENGTH: 3 MTR

SPCA-231

UNIT: 1 SET (2PCS) 250/-

SAP-234

BLACK	4418/-
RG/CG	4683/-
MB/PG	4941/-

1 LENGTH: 3 MTR

SAP-235

BLACK	1895/-
RG/CG	2008/-
MB/PG	2119/-

1 LENGTH: 3 MTR

SPCA-234

UNIT: 1 SET (2PCS) 200/-

SPCA-232

UNIT: 1 SET (2PCS) 120/-

SPCA-233

UNIT: 1 SET (2PCS) 85/-

SPCA-235

UNIT: 1 SET (2PCS) 85/-



Available in Premium Finishes.



LIPIN SHOES SELF

SAP-314		
	BLACK	4035/-
	RG/CG	4277/-
	MB/PG	4512/-
1 LENGTH: 3 MTR		

SAP-315		
	BLACK	4101/-
	RG/CG	4347/-
	MB/PG	4586/-
1 LENGTH: 3 MTR		



MOCHA BROWN



CLASSIC GOLD



ROSE GOLD



CERAMIC BLACK



PORCELAIN GREY

Available in Premium Finishes.

FREE FOLD **SLIDING FOLDING SYSTEM**



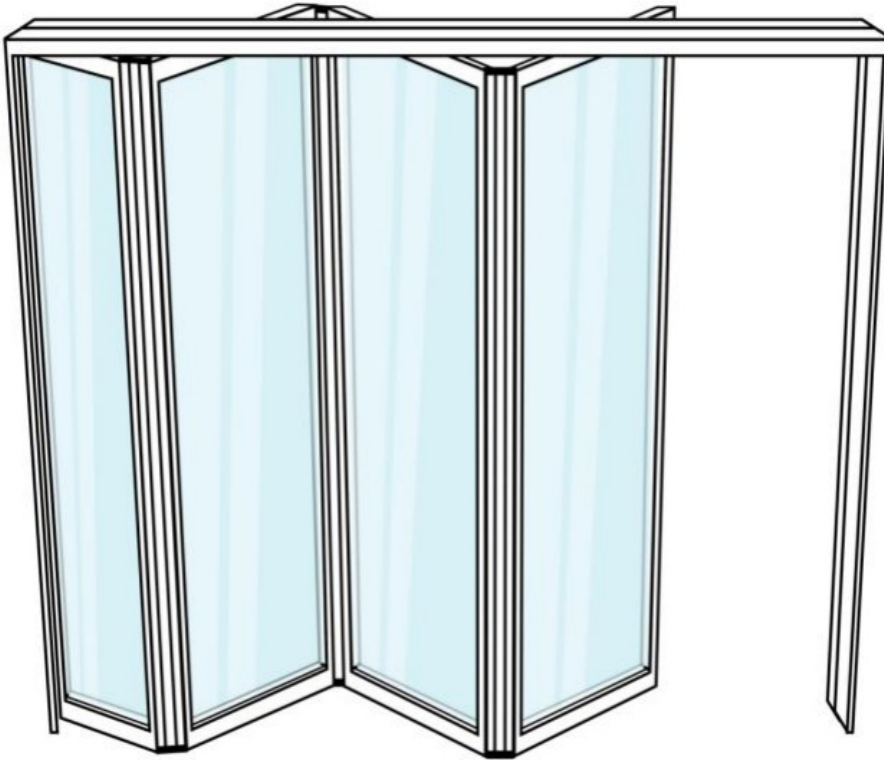

SAP-501		3000	4880
	BLACK	5480/-	9042/-
	RG/CG	5754/-	9494/-
	MB/PG	6042/-	9969/-

SAP-502		3000	4880
	BLACK	3780/-	6237/-
	RG/CG	3969/-	6549/-
	MB/PG	4167/-	6876/-

SAP-503		3000	4880
	BLACK	12692/-	20942/-
	RG/CG	13327/-	21989/-
	MB/PG	13993/-	23088/-

SAP-504		3000	4880
	BLACK	4050/-	6683/-
	RG/CG	4253/-	7017/-
	MB/PG	4465/-	7367/-

SAP-505		3000	4880
	BLACK	14650/-	24173/-
	RG/CG	15383/-	25381/-
	MB/PG	16152/-	26650/-

SAP-506		3000	4880
	BLACK	6050/-	9983/-
	RG/CG	6353/-	10482/-
	MB/PG	6670/-	11006/-

SAP-507		3000	4880
	BLACK	7895/-	13027/-
	RG/CG	8290/-	13678/-
	MB/PG	8704/-	14362/-

SAP-508		3000	4880
	BLACK	8065/-*	13307/-
	RG/CG	8468/-	13973/-
	MB/PG	8892/-	14671/-

SAP-509		3000	4880
	BLACK	880/-	1452/-
	RG/CG	924/-	1525/-
	MB/PG	970/-	1601/-

SAP-510		3000	4880
	BLACK	2850/-	4703/-
	RG/CG	2993/-	4938/-
	MB/PG	3142/-	5185/-

SAP-511		3000	4880
	BLACK	6800/-	11220/-
	RG/CG	7140/-	11781/-
	MB/PG	7497/-	12370/-

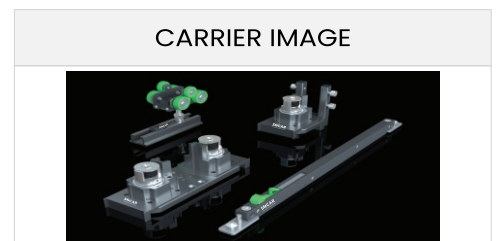

MOCHA BROWN



CLASSIC GOLD



ROSE GOLD



CERAMIC BLACK



PORCELAIN GREY

Available in Premium Finishes.

Fitting Description		SWSF 032 (1+1)	SWSF 032 (1+2)	SWSF 032 (1+3)	SWSF 032 (1+4)	SWSF 032 (1+5)
PRICE		31000/-	50500/-	66835/-	75000/-	92000/-
Double-way folding door hanger		1	1	1	1	1
Free folding door hanging sliding roller		-	1	2	3	4
Two-way folding door with double rotating shaft		2	4	6	8	10
Two-way folding door side shaft		2	2	2	2	2
Dampers		1	1	1	1	1
Heel block		6	10	14	18	22
Free-folding threshold element		1	-	-	-	-
Dampers		1	1	1	1	1



MOCHA BROWN



CLASSIC GOLD



ROSE GOLD



CERAMIC BLACK



PORCELAIN GREY

Available in Premium Finishes.

SLIDING FOLDING SYSTEM



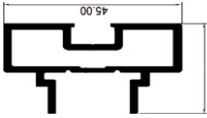

SAP-172 (Horizontal)

	Unit: 1 Length	
	1 Length: 3 Mtr	
	BLACK	5357/-
	RG/CG	5678/-
	MB/PG	5990/-

SAP-173 (Vertical)

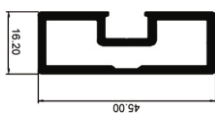
	Unit: 1 Length	
	1 Length: 3 Mtr	
	BLACK	4382/-
	RG/CG	4645/-
	MB/PG	4900/-

SAP-175 (Divider)

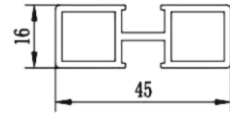
	Unit: 1 Length	
	1 Length: 3 Mtr	
	BLACK	4426/-
	RG/CG	4692/-
	MB/PG	4950/-

SPCA-172 (Connector)

	
1 PCS	400/-

SAP-174 (Stick on Profile)

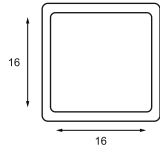
	Unit: 1 Length	
	1 Length: 3 Mtr	
	BLACK	1684/-
	RG/CG	1768/-
	MB/PG	1884/-

SPCA 175

	
PCS	130/-

SGP 1001

	
PCS	500/-

SGT 001

	
PCS	644/-

SAP-202 (Horizontal)

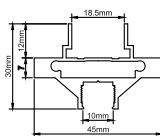
	Unit: 1 Length	
	1 Length: 3 Mtr	
	BLACK	6407/-
	RG/CG	6791/-
	MB/PG	7164/-

SAP-201 (Vertical)

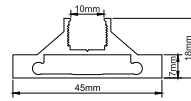
	Unit: 1 Length	
	1 Length: 3 Mtr	
	BLACK	5072/-
	RG/CG	5377/-
	MB/PG	5672/-

SAP-215 (Divider)

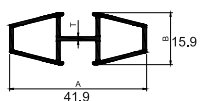
	Unit: 1 Length	
	1 Length: 3 Mtr	
	BLACK	2796/-
	RG/CG	2964/-
	MB/PG	3127/-

SPCA-201 (Connector)

	
1 SET (4 PCS)	220/-

SAP-216 (Stick on Profile)

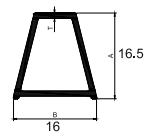
	Unit: 1 Length	
	1 Length: 3 Mtr	
	BLACK	1583/-
	RG/CG	1678/-
	MB/PG	1770/-

SSA-033

	
PCS	790/-

SGP 1002

	
PCS	500/-

SPSFS-801R

	
1 Set	12400/-

SPSFS-801P

	
1 Set	12600/-

SSA-034

	
PCS	800/-

SSA-009AH

	
PCS	1350/-

SPSFS 801 PH

	
UNIT 1 PCS	
BLACK / BRUSH GOLD	850/-

SST-019

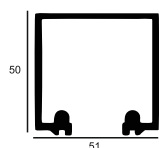
	3660	4880	
	BLACK	11498/-	15330/-
	RG/CG	13222/-	17630/-
	MB/PG	14280/-	19040/-



WARDROBE ACCESSORIES

SR.	IMAGE	ITEM CODE	DESCRIPTION	PER	MRP
1		SWA 401-600	TROUSER RACK W:560 × D:460 × H:50	PCS	10986/-
		SWA 401-800	W:760 × D:460 × H:50	PCS	12754/-
		SWA 401-900	W:860 × D:460 × H:50	PCS	13138/-
2		SWA 402-600	MULTIPURPOSE BOX INNER: ALUMINUM+LEATHER FRONT FRAME WITH LEATHER FINISH: MOCHA+ORANGE W:560 × D:460 × H:50	PCS	18670/-
		SWA 402-800	W:760 × D:460 × H:50	PCS	20821/-
		SWA 402-900	W:860 × D:460 × H:50	PCS	21667/-
3		SWA 403-600	JEWELRY BOX INNER: ALUMINUM+LEATHER FRONT FRAME WITH LEATHER FINISH: MOCHA+ORANGE W:560 × D:460 × H:50	PCS	20360/-
		SWA 403-800	W:760 × D:460 × H:50	PCS	22588/-
		SWA 403-900	W:860 × D:460 × H:50	PCS	23433/-
4		SWA 404-600	LEATHER BASKET INNER: ALUMINUM+LEATHER FRONT FRAME WITH LEATHER FINISH: MOCHA+ORANGE W:560 × D:460 × H:50	PCS	18440/-
		SWA 404-800	W:760 × D:460 × H:50	PCS	20590/-
		SWA 404-900	W:860 × D:460 × H:50	PCS	21436/-
5		SWA 405-600	JEWEL BOX INNER: ALUMINUM+LEATHER FRONT FRAME WITH LEATHER FINISH: MOCHA W:560 × D:460 × H:50	PCS	16903/-
		SWA 405-800	W:760 × D:460 × H:50	PCS	18593/-
		SWA 405-900	W:860 × D:460 × H:50	PCS	19438/-
6		SWA 406	THREE-LAYER ROTATING COMBINATION BASKET INNER: ALUMINUM+LEATHER+PLASTIC FINISH: MOCHA 720 x (1850-2100)MM	PCS	30050/-
7		SWA 407-S	THREE-LAYER ROTATING COMBINATION BASKET INNER: ALUMINUM+LEATHER+PLASTIC FINISH: MOCHA W:700 x D:360 (H:1120-1200)MM	PCS	35850/-
		SWA 407-B	W:700 x D:360 (H:1660-1760)MM	PCS	45330/-
8		SWA 408	TOP-MOUNTED DOUBLE-ROW TROUSER RACK MATERIAL: ALUMINUM+VELVET FINISH: MOCHA W:600 x D:460 x H:150	PCS	8760/-



MOCHA BROWN



CLASSIC GOLD



ROSE GOLD









CERAMIC BLACK

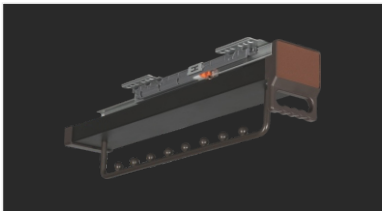
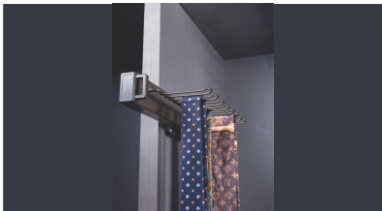

PORCELAIN GREY

Available in Premium Finishes.

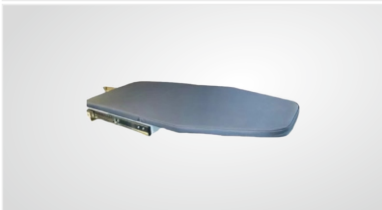
WARDROBE ACCESSORIES

SR.	IMAGE	ITEM CODE	DESCRIPTION	PER	MRP
9		SWA 409	TOP-MOUNTED SINGLE-ROW TROUSER RACK MATERIAL: ALUMINUM+VELVET FINISH: MOCHA W:350 × D:460 × H:150	PCS	8375/-
10		SWA 410-L	SIDE-MOUNTED TROUSER RACK MATERIAL: ALUMINUM+VELVET FINISH: MOCHA W:350 × D:460 × H:150 LEFT	PCS	8150/-
		SWA 410-R	W:350 × D:460 × H:150 RIGHT	PCS	8150/-
11		SWA 411	TOP-MOUNTED CLOTHES HANGER(8 BALLS) MATERIAL: ALUMINUM FINISH: MOCHA W:95 × D:450 × H:120	PCS	6150/-
12		SWA 412	TIE RACK W:400 × D:170 × H:88	PCS	4525/-
13		SWA 413	SAFE BOX W:564 × D:400 × H:150	PCS	38000/-
14		SWA 414	IRONING BOARD WOOD+FABRIC W:300 × D:440 × H:150	PCS	13320/-
15		SWA 415	Adjustable 830mm to 1100mm	PCS	9220/-
16		SWA 416	DRESSING MIRROR MATERIAL: ALUMINUM FINISH: MOCHA 1000 × 340	PCS	6150/-



MOCHA BROWN



CLASSIC GOLD



ROSE GOLD



CERAMIC BLACK



PORCELAIN GREY

Available in Premium Finishes.

SR.	IMAGE	ITEM CODE	DESCRIPTION	PER	MRP
17		SWA 310-800	SHOE RACK 765 x 480 x 160mm	PCS	11193/-
18		SWA 315	TROUSER RACK 450 x 215 x 81mm	PCS	237/-
19		SWA 316	450 x 215 x 81mm	PCS	507/-
20		SWA 319 A	6 Holes	PCS	1013/-
		SWA 319 B	8 Holes	PCS	1239/-
21		SWA 320 A	400 - 700mm	PCS	1309/-
		SWA 320 B	700 - 1100mm	PCS	1582/-



MOCHA BROWN



CLASSIC GOLD



ROSE GOLD



CERAMIC BLACK



PORCELAIN GREY

Available in Premium Finishes.



SAP-253

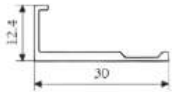

Unit: 1 Length
1 Length: 3 Mtr
Black Matt 1790/-

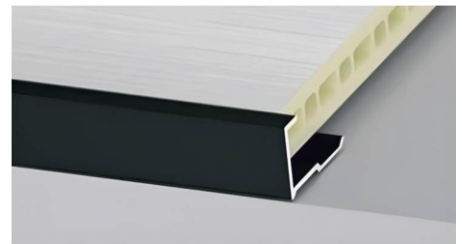
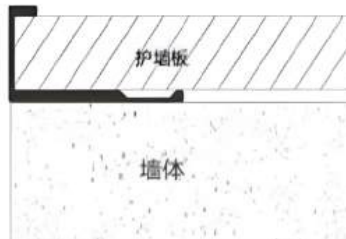

SAP-254

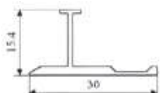

Unit: 1 Length
1 Length: 3 Mtr
Black Matt 2210/-

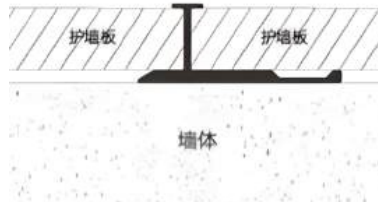

MOCHA BROWN



CLASSIC GOLD



ROSE GOLD



CERAMIC BLACK



PORCELAIN GREY

Available in Premium Finishes.

SAP-255

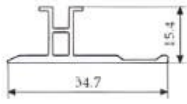

Unit: 1 Length
1 Length: 3 Mtr
Black Matt 2800/-

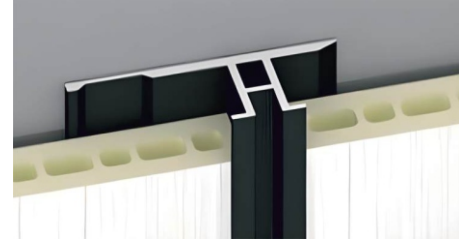
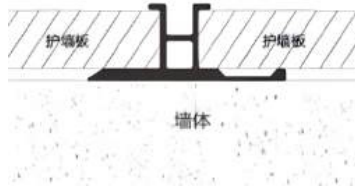

SAP-256

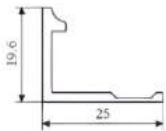

Unit: 1 Length
1 Length: 3 Mtr
Black Matt 3372/-

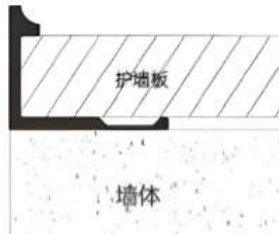

SAP-257

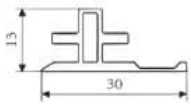

Unit: 1 Length
1 Length: 3 Mtr
Black Matt 3338/-

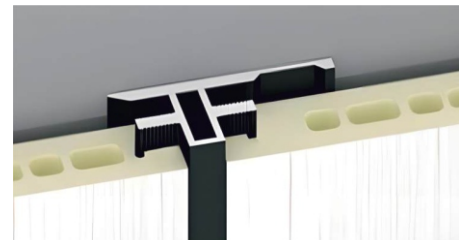
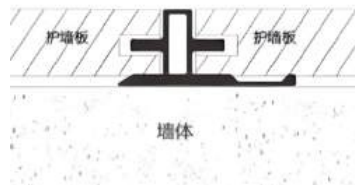

SAP-258

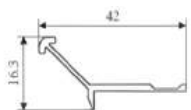

Unit: 1 Length
1 Length: 3 Mtr
Black Matt 2757/-

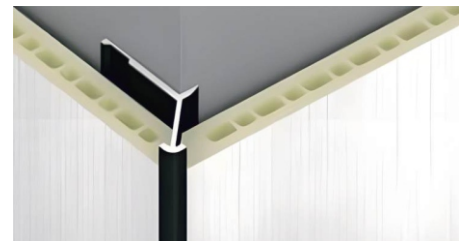
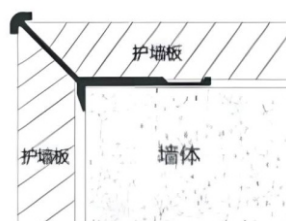

MOCHA BROWN



CLASSIC GOLD



ROSE GOLD



CERAMIC BLACK



PORCELAIN GREY

Available in Premium Finishes.



SAP-259

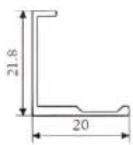

Unit: 1 Length
1 Length: 3 Mtr
Black Matt 2265/-

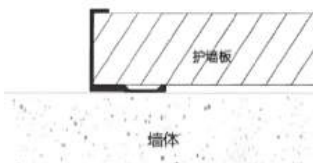

SAP-259-A

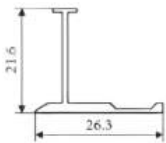

Unit: 1 Length
1 Length: 3 Mtr
Black Matt 2420/-

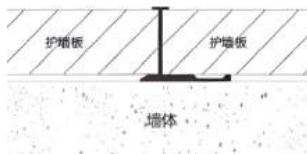

SAP-260

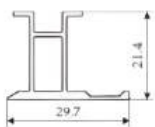

Unit: 1 Length
1 Length: 3 Mtr
Black Matt 3460/-

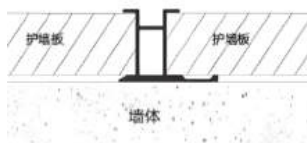

MOCHA BROWN



CLASSIC GOLD



ROSE GOLD



CERAMIC BLACK



PORCELAIN GREY

Available in Premium Finishes.

SAP-261

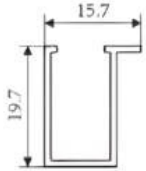

Unit: 1 Length
1 Length: 3 Mtr
Black Matt 2275/-

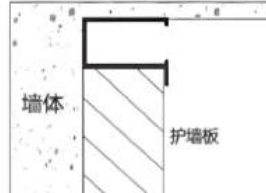

SAP-262

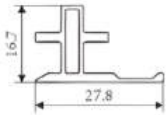

Unit: 1 Length
1 Length: 3 Mtr
Black Matt 3515/*-

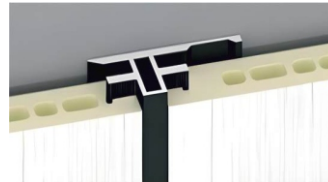

SAP-263

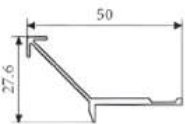

Unit: 1 Length
1 Length: 3 Mtr
Black Matt 3015/-

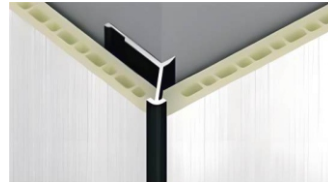
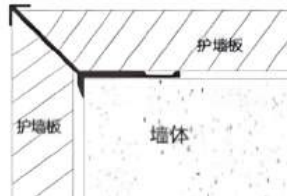

MOCHA BROWN



CLASSIC GOLD



ROSE GOLD



CERAMIC BLACK



PORCELAIN GREY

Available in Premium Finishes.



PERFECT (40X16) TELESCOPIC SLIDING

SINGLE MOVING DOOR SLIDING SYSTEM
SWSF 051



UNIT: SET 19500/-

SINGLE MOVING POCKET DOOR SLIDING
PUSH TO OPEN
SWSF 052



UNIT: SET 30500/-

2 MOVING DOOR SLIDING SYSTEM
SWSF 051-2



UNIT: SET 30,000/-

3 MOVING DOOR SLIDING SYSTEM
SWSF 051-3



UNIT: SET 49,000/-

4 MOVING DOOR SLIDING SYSTEM
SWSF 051-4



UNIT: SET 70,000/-

5 MOVING DOOR SLIDING SYSTEM
SWSF 051-5

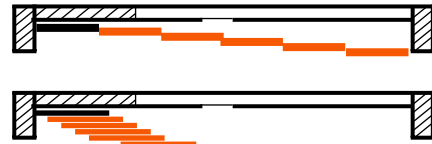

UNIT: SET 89000/-

SYNCHRO SLIDING DOOR
SWSF 053



UNIT: SET 52500/-

CARRIER IMAGE



MOCHA BROWN



CLASSIC GOLD



ROSE GOLD



CERAMIC BLACK



PORCELAIN GREY

Available in Premium Finishes.

PERFECT (40X16) TELESCOPIC SLIDING

SAP-401 (TOP/BOTTOM FRAME)

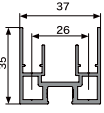

	3000	4880
BLACK	5749/-	9042/-
RG/CG	6439/-	10127/-
MB/PG	6954/-	10937/-

SAP-402 (VERTICAL)

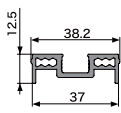

	3000	4880
BLACK	3501/-	5445/-
RG/CG	3921/-	6098/-
MB/PG	4235/-	6586/-

SAP-403 (COVER FOR VERTICAL)

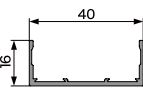

	3000	4880
BLACK	2449/-	3762/-
RG/CG	2743/-	4213/-
MB/PG	2963/-	4550/-

SAP-404 (COVER WITH BRUSH FOR VERTICAL)

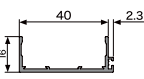

	3000	6000
BLACK	3000/-	6000/-
RG/CG	3360/-	6720/-
MB/PG	3629/-	7258/-

SAP-405 (DIVIDER)

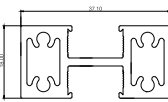

	3000	4880
BLACK	5482/-	8614/-
RG/CG	6140/-	9648/-
MB/PG	6631/-	10420/-

SAP-406 (L SHAPE DOOR VERTICAL)

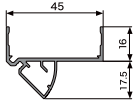

	3000	4880
BLACK	3925/-	7850/-
RG/CG	4396/-	8792/-
MB/PG	4748/-	9495/-

SST-051 (TOP SINGLE RUNNING TRACK)

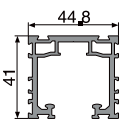

	3000	4880
BLACK	9338/-	14785/-
RG/CG	10459/-	16559/-
MB/PG	11296/-	17883/-

SST-051 A (TRACK DECORATIVE COVER)

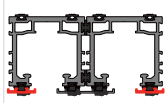

	3000	4880
BLACK	1106/-	1613/-
RG/CG	1239/-	1806/-
MB/PG	1338/-	1951/-

SST-051 B (TRACK DECORATIVE COVER)

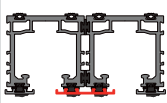

	3000	4880
BLACK	1645/-	2475/-
RG/CG	1842/-	2772/-
MB/PG	1990/-	2994/-

SST-051 C (Bottom side Cover, Side decorative cover for concealed track installation 6000mm)



	3000
BLACK	2750/-
RG/CG	3080/-
MB/PG	3326/-

SST-051 D (COVER FOR TRACK)

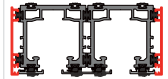

	3000	4880
BLACK	2214/-	3386/-
RG/CG	2480/-	3792/-
MB/PG	2679/-	4096/-

SSH-004



BLACK	1450/-
RG/CG	1650/-
MB/PG	1850/-

UNIT: PCS

SSH-005



BLACK	1650/-
RG/CG	1850/-
MB/PG	2050/-

UNIT: PCS

SSH-006



BLACK	2050/-
RG/CG	2350/-
MB/PG	2550/-

UNIT: PCS

SGP 3001



500/-

UNIT: PCS



MOCHA BROWN



CLASSIC GOLD



ROSE GOLD



CERAMIC BLACK



PORCELAIN GREY

Available in Premium Finishes.

SSH008 Z HANDLE STICK ON



BLACK	850/-
RG/CG	850/-
MB/PG	850/-

UNIT: PCS

SSL003

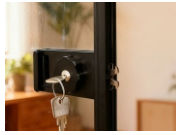

BLACK	6350/-
RG/CG	6750/-
MB/PG	6950/-

UNIT: PCS

SSL004

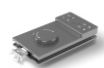

BLACK	31,550/-
RG/CG	31,550/-
MB/PG	31,550/-

UNIT: PCS

SRS-021 (RUBBER FOR CORNER PROFILE)



UNIT: MTR 100/-

SRS-022 (TOP TRACK RUBBER)



UNIT: MTR 45/-

SRS-023 (VERTICAL RUBBER)



UNIT: MTR 40/-

SSHWL-003



BLACK	5000/-
RG/CG	5500/-
MB/PG	6000/-

UNIT: 1 PCS

SSA-051 A



FIX DOOR ELITE

UNIT: 1 SET 4000/-

SSA-051 B



MOUNTING DOOR FITTING

UNIT: 1 SET 950/-

SSA-051 C

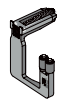

BELL CORNER

UNIT: 1 SET 1350/-

SSA-051 D



FRAME CONNECTING

UNIT: PCS 50/-

SSA-051 E

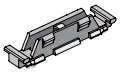

CHIP FOR CORNER TRACK FITTING

UNIT: PCS 20/-

SSA-051 F



FRAME ASSEMBLE CLIP

UNIT: PCS 20/-

SSA-051 G



MOUNTING TOOL

UNIT: 1 SET 18,000/-

SSA-051 H



BELL SIZE LOCATEN

UNIT: 1 SET 150/-

SSA-053



MEGNET FOR CORNER PROFILE

UNIT: 1 SET 2000/-

SSA-016



UNIT: MTR 800/-



Available in Premium Finishes.

Extremely exquisite craft gap

Create a "seamless" sliding door,
High craft requirements are
No longer restricted!

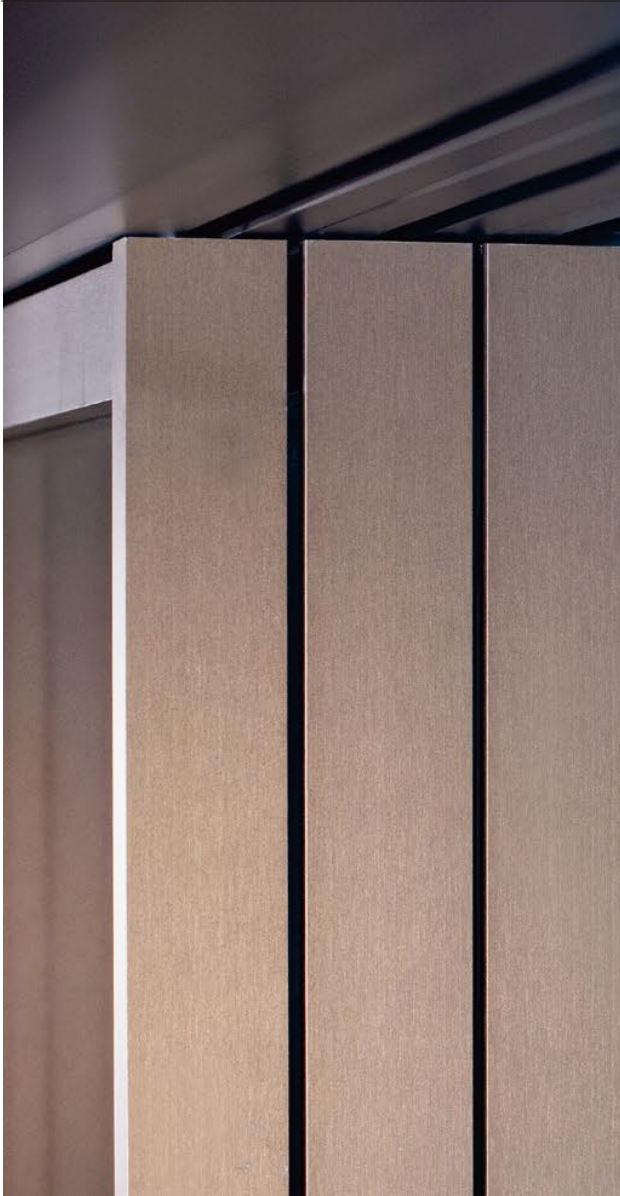

6mm
track
visible gap

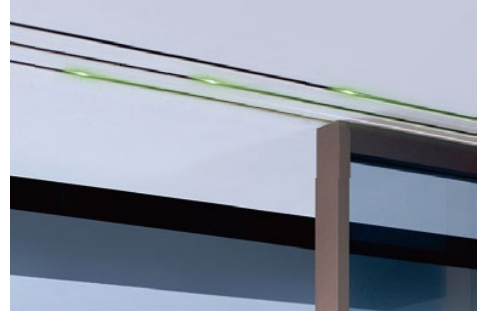

3mm
bottom gap



1mm
top gap



0mm
side gap

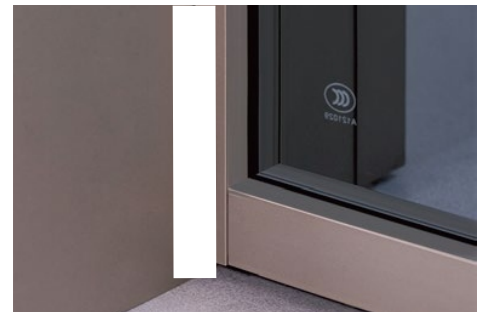

3mm
doors gap

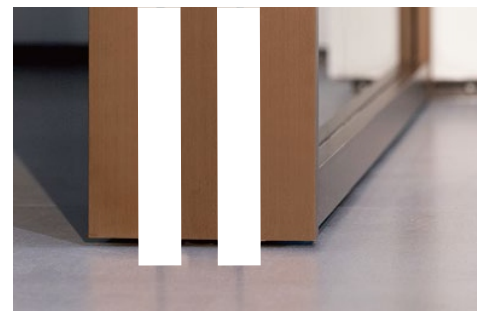

TARVOS (45X16) TELESCOPIC SLIDING



TARVOS (45X16) TELESCOPIC SLIDING

SINGLE MOVING DOOR SLIDING SYSTEM
SWSF 025 P



UNIT: SET

12,110/-

2 MOVING DOOR SLIDING SYSTEM
SWSF 022-2



UNIT: SET

26,150/-

3 MOVING DOOR SLIDING SYSTEM
SWSF 022-3



UNIT: SET

33,050/-

4 MOVING DOOR SLIDING SYSTEM
SWSF 022-4



UNIT: SET

38,480/-

5 MOVING DOOR SLIDING SYSTEM
SWSF 022-5

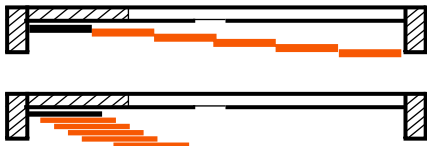

UNIT: SET

44,500/-

SYNCHRO SLIDING DOOR
SWSF 023



UNIT: SET

30,570/-

CARRIER IMAGE



MOCHA BROWN



CLASSIC GOLD



ROSE GOLD



CERAMIC BLACK



PORCELAIN GREY

Available in Premium Finishes.

TARVOS (45X16) TELESCOPIC SLIDING

SAP-172 (HORIZONTAL)

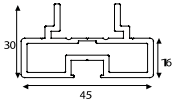

1 LENGTH: 3 MTR

BLACK	5357/-
RG/CG	5678/-
MB/PG	5990/-

SAP-173 (VERTICAL)

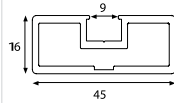

1 LENGTH: 3 MTR

	3000	4880
BLACK	4382/-	6906/-
RG/CG	4645/-	7321/-
MB/PG	4900/-	7723/-

SAP-171 (INTERLOCKING)

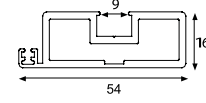

1 LENGTH: 3 MTR

BLACK	5008/-
RG/CG	5308/-
MB/PG	5600/-

SAP-175 (DIVIDER)

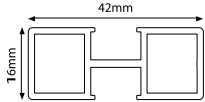

1 LENGTH: 3 MTR

BLACK	4426/-
RG/CG	4692/-
MB/PG	4950/-

SAP-174 (STICK ON PROFILE)

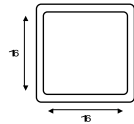

1 LENGTH: 3 MTR

BLACK	1684/-
RG/CG	1786/-
MB/PG	1884/-

SAP-206 (STICK ON PROFILE)

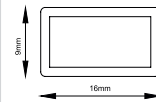

1 LENGTH: 3 MTR

	3000	4880
BLACK	2125/-	3265/-
RG/CG	2253/-	3461/-
MB/PG	2377/-	3651/-

SST-022 CARRIER TRACK

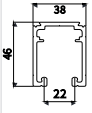

	2440	3660	4880
BLACK	5719/-	8578/-	9365/-
RG/CG	6119/-	9178/-	10,021/-
MB/PG	6547/-	9821/-	10,722/-

SST-023 TRACK COVER

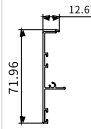

	2440	3660	4000	4880
BLACK	2491/-	4062/-	4431/-	5416/-
RG/CG	2665/-	4346/-	4742/-	5795/-
MB/PG	2852/-	4650/-	5074/-	6201/-

SSH-001 (SLIDING HANDLE)



UNIT: PCS

BLACK	1200/-
RG/CG	1200/-
MB/PG	1300/-

SSHWL-001 (SLIDING HANDLE WITH LOCK)



UNIT: PCS

BLACK	2460/-
RG/CG	2706/-
MB/PG	2706/-

SSA-01



UNIT: 1 SET

2400/-

SPCA-172A



UNIT: PCS

280/-

SPCA-172



UNIT: PCS

400/-

SGP 1001



UNIT: PCS

500/-

SGT 001



UNIT: PCS

644/-

SPCA-175



UNIT: PCS

130/-

SAP-208



1 LENGTH: 3 MTR

BLACK	3842/-
RG/CG	4072/-
MB/PG	4296/-

SSL001 (SLIM PROFILE LOCK)



UNIT: PCS

BLACK	8250/-
RG/CG	8750/-
MB/PG	9250/-

SSL003

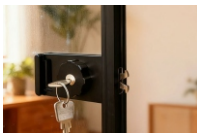

UNIT: PCS

BLACK	6350/-
RG/CG	6750/-
MB/PG	6950/-

SSL004



UNIT: PCS

BLACK	31,550/-
RG/CG	31,550/-
MB/PG	31,550/-

SSH008 Z HANDLE STICK ON

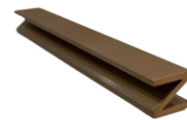

UNIT: PCS

BLACK	850/-
RG/CG	850/-
MB/PG	850/-



MOCHA BROWN



CLASSIC GOLD



ROSE GOLD



CERAMIC BLACK



PORCELAIN GREY

Available in Premium Finishes.

TARVOS (45X16) TELESCOPIC SLIDING





**SINGLE MOVING DOOR SLIDING SYSTEM
SWSF 025 P**



UNIT: SET

12,110/-

**2 MOVING DOOR SLIDING SYSTEM
SWSF 022-2**



UNIT: SET

26,150/-

**3 MOVING DOOR SLIDING SYSTEM
SWSF 022-3**



UNIT: SET

33,050/-

**4 MOVING DOOR SLIDING SYSTEM
SWSF 022-4**

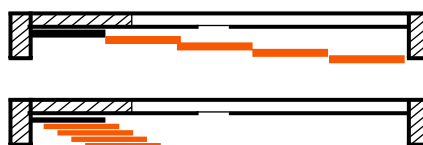

UNIT: SET

38,480/-

**5 MOVING DOOR SLIDING SYSTEM
SWSF 022-5**

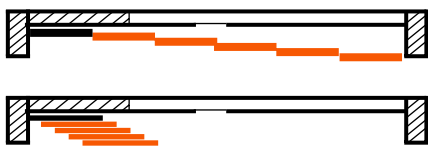

UNIT: SET

44,500/-

**SYNCHRO SLIDING DOOR
SWSF 023**



UNIT: SET

30,570/-

CARRIER IMAGE



MOCHA BROWN



CLASSIC GOLD



ROSE GOLD



CERAMIC BLACK



PORCELAIN GREY

Available in Premium Finishes.

SAP-295 (HORIZONTAL)

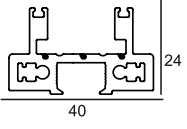

BLACK	6270/-
RG/CG	6646/-
MB/PG	7012/-

1 LENGTH: 3 MTR

SAP-294 (VERTICAL)

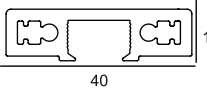

BLACK	4647/-
RG/CG	4926/-
MB/PG	5197/-

1 LENGTH: 3 MTR

SAP-296 (DIVIDER)

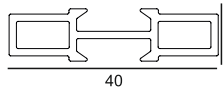

BLACK	3119/-
RG/CG	3306/-
MB/PG	3487/-

1 LENGTH: 3 MTR

SGP 1005



UNIT: 1 SET	500/-
-------------	-------

SSA-01 (FIXED ACCESSORIES)



UNIT: 1 SET	2400/-
-------------	--------

SAP-236

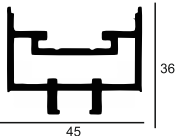

BLACK	7182/-
RG/CG	7613/-
MB/PG	8031/-

1 LENGTH: 3 MTR

SAP-237

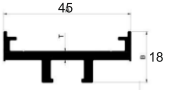

BLACK	4253/-
RG/CG	4508/-
MB/PG	4756/-

1 LENGTH: 3 MTR

SAP-238

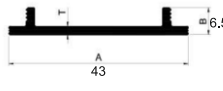

BLACK	2197/-
RG/CG	2329/-
MB/PG	

1 LENGTH: 3 MTR

SST-022 CARRIER TRACK

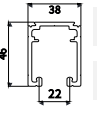

	2440	3660	4880
BLACK	5719/-	8578/-	9365/-
RG/CG	6119/-	9178/-	10,021/-
MB/PG	6547/-	9821/-	10,722/-

SST-023 TRACK COVER

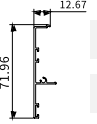

	2440	3660	4000	4880
BLACK	2491/-	4062/-	4431/-	5416/-
RG/CG	2665/-	4346/-	4742/-	5795/-
MB/PG	2852/-	4650/-	5074/-	6201/-

SSH-001 (SLIDING HANDLE)



BLACK	1200/-
RG/CG	1200/-
MB/PG	1300/-

UNIT: PCS

SSHWL-001

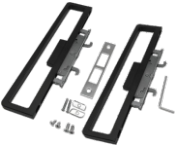

BLACK	2460/-
RG/CG	2706/-
MB/PG	2706/-

UNIT: PCS UNIT: PCS

SPCA-236



UNIT: PCS	500/-
-----------	-------

SGP 1005



UNIT: PCS	500/-
-----------	-------

SSH008 Z HANDLE STICK ON



BLACK	850/-
RG/CG	850/-
MB/PG	850/-

UNIT: PCS

SSL003



BLACK	6350/-
RG/CG	6750/-
MB/PG	6950/-

UNIT: PCS

SSL004



BLACK	31,550/-
RG/CG	31,550/-
MB/PG	31,550/-

UNIT: PCS





PRISM (42X10) TELESCOPIC SLIDING



PRISM (42X10) TELESCOPIC SLIDING

**SINGLE MOVING DOOR SLIDING SYSTEM
SWSF 025 P**



UNIT: SET	12,110/-
-----------	----------

**2 MOVING DOOR SLIDING SYSTEM
SWSF 022-2**

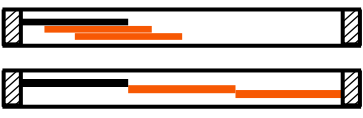

UNIT: SET	26,150/-
-----------	----------

**3 MOVING DOOR SLIDING SYSTEM
SWSF 022-3**



UNIT: SET	33,050/-
-----------	----------

**4 MOVING DOOR SLIDING SYSTEM
SWSF 022-4**

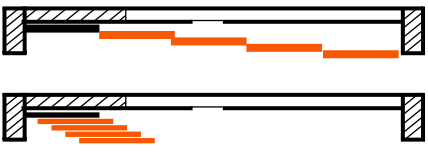

UNIT: SET	38,480/-
-----------	----------

**5 MOVING DOOR SLIDING SYSTEM
SWSF 022-5**

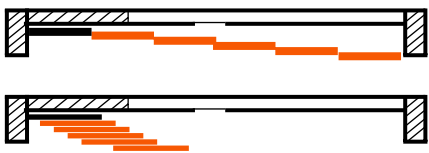

UNIT: SET	44,500/-
-----------	----------

**SYNCHRO SLIDING DOOR
SWSF 023**



UNIT: SET	30,570/-
-----------	----------

CARRIER IMAGE



- 
MOCHA BROWN
- 
CLASSIC GOLD
- 
ROSE GOLD
- 
CERAMIC BLACK
- 
PORCELAIN GREY

Available in Premium Finishes.

PRISM (42X10) TELESCOPIC SLIDING

SAP-298 (HORIZONTAL)

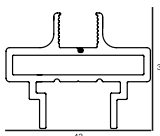

BLACK	5728/-
RG/CG	6071/-
MB/PG	6405/-

1 LENGTH: 3 MTR

SAP-297 (VERTICAL)

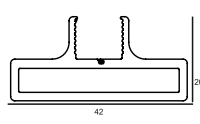

BLACK	4557/-
RG/CG	4830/-
MB/PG	5096/-

1 LENGTH: 3 MTR

SAP-299 (DIVIDER)

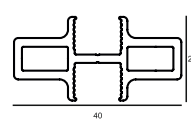

BLACK	4378/-
RG/CG	4641/-
MB/PG	4896/-

1 LENGTH: 3 MTR

SST-022 CARRIER TRACK

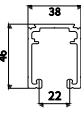

	2440	3660	4880
BLACK	5719/-	8578/-	9365/-
RG/CG	6119/-	9178/-	10,021/-
MB/PG	6547/-	9821/-	10,722/-

SST-023 TRACK COVER

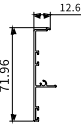

	2440	3660	4000	4880
BLACK	2491/-	4062/-	4431/-	5416/-
RG/CG	2665/-	4346/-	4742/-	5795/-
MB/PG	2852/-	4650/-	5074/-	6201/-

SAP-206 (STICK ON PROFILE)

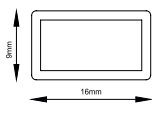

	3000	4880
BLACK	2125/-	3265/-
RG/CG	2253/-	3461/-
MB/PG	2377/-	3651/-

1 LENGTH: 3 MTR

SSH-001 (SLIDING HANDLE)



BLACK	1200/-
RG/CG	1200/-
MB/PG	1300/-

UNIT: PCS

SPCA-298 (CONNECTOR)



UNIT: PCS	280/-
-----------	-------

SSA-01 (FIXED ACCESSORIES)



UNIT: 1 SET	2400/-
-------------	--------

SGP 1006



UNIT: PCS	500/-
-----------	-------

SSH008 Z HANDLE STICK ON



BLACK	850/-
RG/CG	850/-
MB/PG	850/-

UNIT: PCS

SSL003

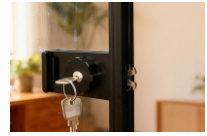

BLACK	6350/-
RG/CG	6750/-
MB/PG	6950/-

UNIT: PCS

SSL004



BLACK	31,550/-
RG/CG	31,550/-
MB/PG	31,550/-

UNIT: PCS



Available in Premium Finishes.

PRISM (42X10) TELESCOPIC SLIDING



ESILE (45X07) TELESCOPIC SLIDING



ESILE (45X07) TELESCOPIC SLIDING

**SINGLE MOVING DOOR SLIDING SYSTEM
SWSF 025 P**



UNIT: SET	12,110/-
-----------	----------

**2 MOVING DOOR SLIDING SYSTEM
SWSF 022-2**

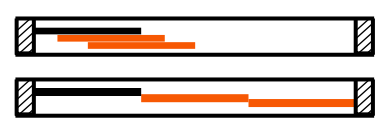

UNIT: SET	26,150/-
-----------	----------

**3 MOVING DOOR SLIDING SYSTEM
SWSF 022-3**

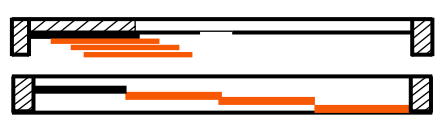

UNIT: SET	33,050/-
-----------	----------

**4 MOVING DOOR SLIDING SYSTEM
SWSF 022-4**

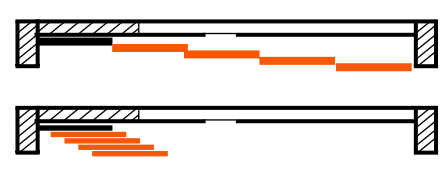

UNIT: SET	38,480/-
-----------	----------

**5 MOVING DOOR SLIDING SYSTEM
SWSF 022-5**

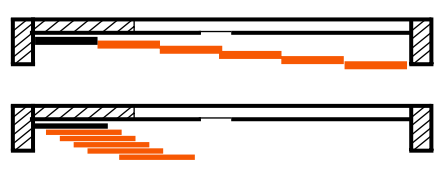

UNIT: SET	44,500/-
-----------	----------

**SYNCHRO SLIDING DOOR
SWSF 023**



UNIT: SET	30,570/-
-----------	----------

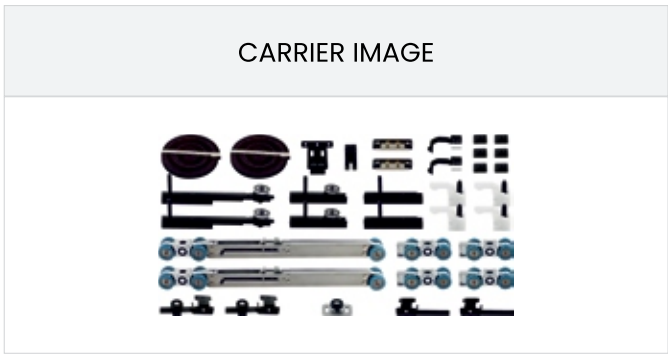

- 
MOCHA BROWN
- 
CLASSIC GOLD
- 
ROSE GOLD
- 
CERAMIC BLACK
- 
PORCELAIN GREY

Available in Premium Finishes.

ESILE (45X07) TELESCOPIC SLIDING

SAP-202 (HORIZONTAL)

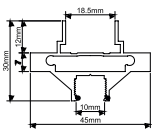

BLACK	6407/-
RG/CG	6791/-
MB/PG	7164/-

1 LENGTH: 3 MTR

SAP-201 (VERTICAL)

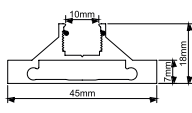

BLACK	5072/-
RG/CG	5377/-
MB/PG	5672/-

1 LENGTH: 3 MTR

SAP-203 (INTERLOCKING)

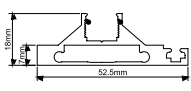

BLACK	5725/-
RG/CG	6069/-
MB/PG	6403/-

1 LENGTH: 3 MTR

SAP-215 (DIVIDER)

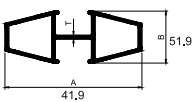

BLACK	2796/-
RG/CG	2964/-
MB/PG	3127/-

1 LENGTH: 3 MTR

SAP-216 (STICK ON PROFILE)

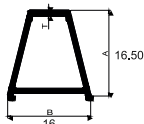

BLACK	1583/-
RG/CG	1678/-
MB/PG	1770/-

1 LENGTH: 3 MTR

SPCA-201



UNIT: PCS 220/-

SPCA-201A



UNIT: PCS 280/-

SST-022 CARRIER TRACK

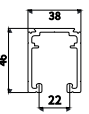

	2440	3660	4880
BLACK	5719/-	8578/-	9365/-
RG/CG	6119/-	9178/-	10,021/-
MB/PG	6547/-	9821/-	10,722/-

SST-023 TRACK COVER

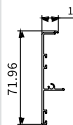

	2440	3660	4000	4880
BLACK	2491/-	4062/-	4431/-	5416/-
RG/CG	2665/-	4346/-	4742/-	5795/-
MB/PG	2852/-	4650/-	5074/-	6201/-

SSH-002 (SLIDING HANDLE)



BLACK	1950/-
RG/CG	2150/-
MB/PG	2150/-

UNIT: PCS

SSHWL-002 (SLIDING HANDLE WITH LOCK)



BLACK	2950/-
RG/CG	3150/-
MB/PG	3150/-

UNIT: PCS

SSA-01 (FIXED ACCESSORIES)



UNIT: 1 SET 2400/-

SGP 1002



UNIT: PCS 500/-

SGT 001



UNIT: 1 SET 644/-

SSL002 (SLIM PROFILE LOCK)



BLACK	9075/-
RG/CG	9625/-
MB/PG	10,170/-

UNIT: PCS

SSH008 Z HANDLE STICK ON



BLACK	850/-
RG/CG	850/-
MB/PG	850/-

UNIT: PCS



MOCHA BROWN



CLASSIC GOLD



ROSE GOLD



CERAMIC BLACK



PORCELAIN GREY

Available in Premium Finishes.

ESILE (45X07) TELESCOPIC SLIDING



CURVO (45X16) TELESCOPIC SLIDING



CURVO (45X16) TELESCOPIC SLIDING

**SINGLE MOVING DOOR SLIDING SYSTEM
SWSF 025 P**



UNIT: SET	12,110/-
-----------	----------

**2 MOVING DOOR SLIDING SYSTEM
SWSF 022-2**

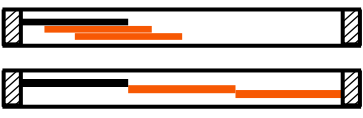

UNIT: SET	26,150/-
-----------	----------

**3 MOVING DOOR SLIDING SYSTEM
SWSF 022-3**



UNIT: SET	33,050/-
-----------	----------

**4 MOVING DOOR SLIDING SYSTEM
SWSF 022-4**

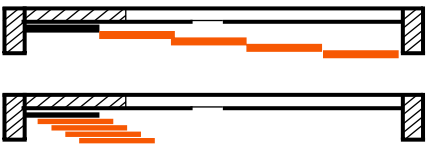

UNIT: SET	38,480/-
-----------	----------

**5 MOVING DOOR SLIDING SYSTEM
SWSF 022-5**

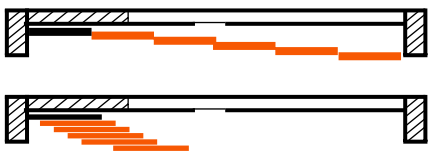

UNIT: SET	44,500/-
-----------	----------

**SYNCHRO SLIDING DOOR
SWSF 023**



UNIT: SET	30,570/-
-----------	----------

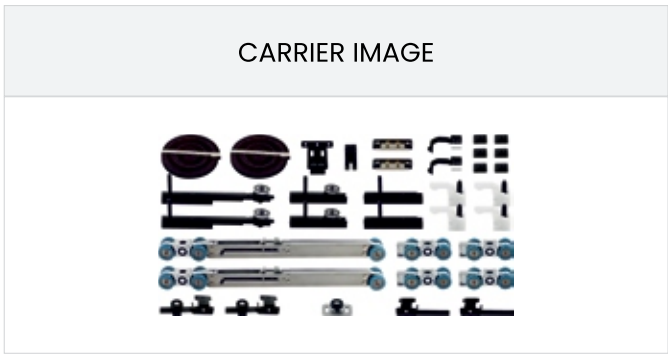

- 
MOCHA BROWN
- 
CLASSIC GOLD
- 
ROSE GOLD
- 
CERAMIC BLACK
- 
PORCELAIN GREY

Available in Premium Finishes.

CURVO (45X16) TELESCOPIC SLIDING

SAP-204 (VERTICAL)

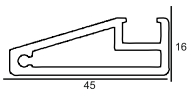

BLACK	4681/-
RG/CG	4962/-
MB/PG	5235/-

1 LENGTH: 3 MTR

SAP-205 (HORIZONTAL)

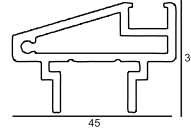

BLACK	6061/-
RG/CG	6424/-
MB/PG	6777/-

1 LENGTH: 3 MTR

SPCA-204 (CONNECTOR)



UNIT:PCS	700/-
----------	-------

SST-022 CARRIER TRACK

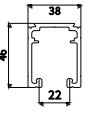

	2440	3660	4880
BLACK	5719/-	8578/-	9365/-
RG/CG	6119/-	9178/-	10,021/-
MB/PG	6547/-	9821/-	10,722/-

SST-023 TRACK COVER

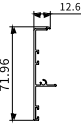

	2440	3660	4000	4880
BLACK	2491/-	4062/-	4431/-	5416/-
RG/CG	2665/-	4346/-	4742/-	5795/-
MB/PG	2852/-	4650/-	5074/-	6201/-

SSH008 Z HANDLE STICK ON



BLACK	850/-
RG/CG	850/-
MB/PG	850/-

UNIT: PCS

SSA-01 (FIXED ACCESSORIES)



UNIT: 1 SET	2400/-
-------------	--------

SGP 1001



UNIT: PCS	500/-
-----------	-------

SAP-273



BLACK	1376/-
RG/CG	1459/-
MB/PG	1539/-

1 LENGTH: 3 MTR

PERK (40X10) TELESCOPIC SLIDING

SAP-316 (HORIZONTAL)

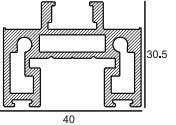

BLACK	7712/-
RG/CG	8175/-
MB/PG	8625/-

1 LENGTH: 3 MTR

SAP-317 (VERTICAL)

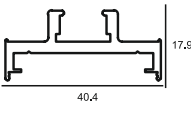

BLACK	4089/-
RG/CG	4334/-
MB/PG	4573/-

1 LENGTH: 3 MTR

SAP-318

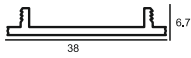

BLACK	2407/-
RG/CG	2552/-
MB/PG	2692/-

1 LENGTH: 3 MTR

SSH-001 (SLIDING HANDLE)



BLACK	1200/-
RG/CG	1200/-
MB/PG	1300/-

UNIT: PCS

SGP 1003



UNIT: PCS	500/-
-----------	-------

SPCA-315

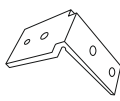

UNIT: 1 SET	300/-
-------------	-------



MOCHA BROWN



CLASSIC GOLD



ROSE GOLD



CERAMIC BLACK



PORCELAIN GREY

Available in Premium Finishes.

CURVO (45X16) TELESCOPIC SLIDING



BELIMOS INVISIBLE SLIDING



COMPONENTS

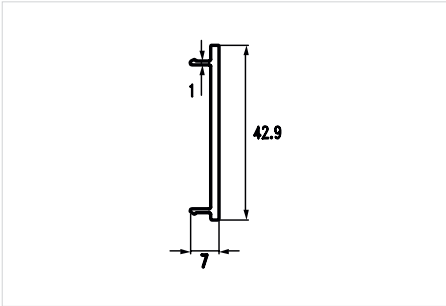
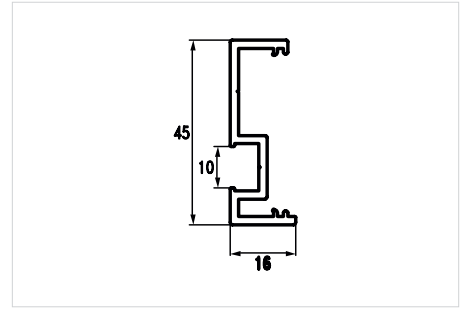
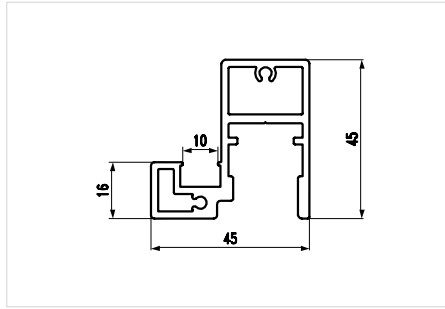
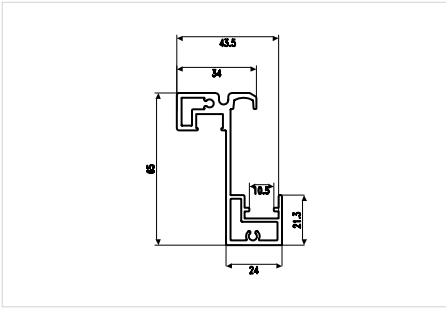

SWSF 026 CARRIER (BOTH SIDE SOFT CLOSE)



UNIT: 1 SET

51,634/-



MOCHA BROWN



CLASSIC GOLD



ROSE GOLD



CERAMIC BLACK



PORCELAIN GREY

Available in Premium Finishes.

MAGNETIC AUTOMATIC TELESCOPIC SLIDING(2+1,3+1)



MAGNETIC AUTOMATIC TELESCOPIC SLIDING(2+1,3+1)

2 MOVING DOOR SLIDING SYSTEM
SWSF 024-2 WITH 4000MM



UNIT: SET

2,30,000/-

3 MOVING DOOR SLIDING SYSTEM
SWSF 024-3 WITH 4000MM

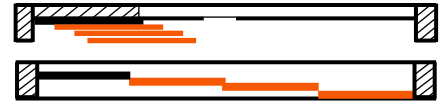

UNIT: SET

2,45,000/-

SST-024 Carrier Track

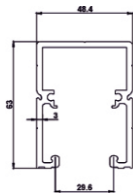

1 Length: 4.2 Mtr

Black Matt

SST-025 Track Cover

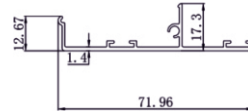

1 Length: 4.2 Mtr

Black Matt

SENSOR



REMOTE



AUTOMATIC SLIDING DOOR (SENSOR/REMOTE)



MOCHA BROWN



CLASSIC GOLD



ROSE GOLD



CERAMIC BLACK



PORCELAIN GREY

Available in Premium Finishes.

SAP-202 (HORIZONTAL)

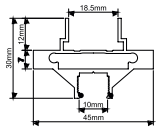

BLACK	6407/-
RG/CG	6791/-
MB/PG	7164/-

1 LENGTH: 3 MTR

SAP-201 (VERTICAL)

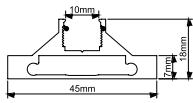

BLACK	5072/-
RG/CG	5377/-
MB/PG	5672/-

1 LENGTH: 3 MTR

SAP-216 (STICK ON PROFILE)

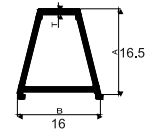

BLACK	1583/-
RG/CG	1678/-
MB/PG	1770/-

1 LENGTH: 3 MTR

SAP-215 (DIVIDER)

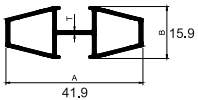

BLACK	2796/-
RG/CG	2964/-
MB/PG	3127/-

1 LENGTH: 3 MTR

SGP 1002



UNIT: PCS 500/-

SPCA-201



UNIT: PCS 220/-

SPCA-201A



UNIT: PCS 280/-

SAP-172 (HORIZONTAL)

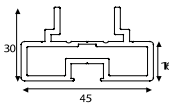

BLACK	5357/-
RG/CG	5678/-
MB/PG	5990/-

1 LENGTH: 3 MTR

SAP-173 (VERTICAL)

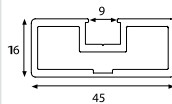

	3100	4880
BLACK	4382/-	6906/-
RG/CG	4645/-	7321/-
MB/PG	4900/-	7723/-

1 LENGTH: 3 MTR

SAP-171 (INTERLOCKING)

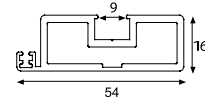

BLACK	5008/-
RG/CG	5308/-
MB/PG	5600/-

1 LENGTH: 3 MTR

SAP-175 (DIVIDER)

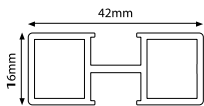

BLACK	4426/-
RG/CG	4692/-
MB/PG	4950/-

1 LENGTH: 3 MTR

SAP-174 (STICK ON PROFILE)

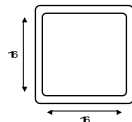

BLACK	1684/-
RG/CG	1786/-
MB/PG	1884/-

1 LENGTH: 3 MTR

SAP-206 (STICK ON PROFILE)

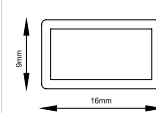

	3000	4880
BLACK	2125/-	3265/-
RG/CG	2253/-	3461/-
MB/PG	2377/-	3651/-

SGT 001



UNIT: PCS 644/-

SPCA-175



UNIT: PCS 130/-

SPCA-172A



UNIT: PCS 280/-

SPCA-172



UNIT: PCS 400/-

SGP 1001



UNIT: PCS 500/-



MOCHA BROWN



CLASSIC GOLD



ROSE GOLD



CERAMIC BLACK



PORCELAIN GREY

AUTOMATIC SENSOR DOOR



FUNCTIONAL FEATURES

- Microcomputer intelligent control and advanced machinery manufacturing;
- Intelligent control system, all kinds of parameters can be adjusted flexibly;
- Low noise power unit, simple and convenient installation.
- Integrated brushless motor and gearbox, high efficiency, large torque, long life;
- Self-locking function, no electric lock, safe and reliable.
- Full-function remote control device.

Functional Features

HD-150

	Single Door	Double Door
Slide type	Single Door	Double Door
Load weight	≤150kg	≤2×125kg
Supply Voltage	AC220V~240V:50~60Hz	
Sensing form	Suitable for all types of mode sensors	
Opening speed	200~450mm/s (Adjustable)	
Closing speed	200~450mm/s (Adjustable)	
Opening speed	200~450mm/s (Adjustable)	
Opening time	0~9s	
Manual opening force	<40N	<50N
Operating noise	≤55dB	
Ambient humidity	-20~+50°C	

TRAVOS AUTOMATIC SENSOR DOOR

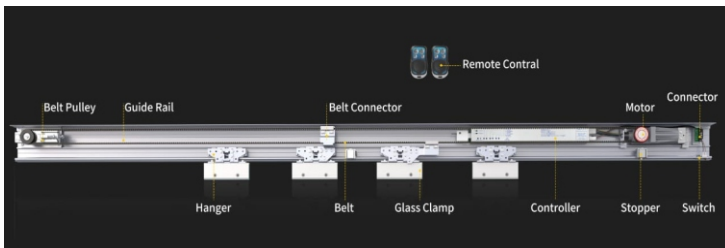

ITEM CODE	DESCRIPTION	ITEM	MRP
SSD001P	Automatic Sensor Door System With 5 Meter Track, 4 PCS Small Clamp And Two In One Function Sensor (Sensor+Safety Beam)	SET	188000/-

SAP-172 (HORIZONTAL)		
<p>1 LENGTH: 3 MTR</p>	BLACK	5357/-
	RG/CG	5678/-
	MB/PG	5990/-

SAP-173 (VERTICAL)		
<p>1 LENGTH: 3 MTR</p>	BLACK	4382/-
	RG/CG	4645/-
	MB/PG	4900/-

SAP-175 (DIVIDER)		
<p>1 LENGTH: 3 MTR</p>	BLACK	4426/-
	RG/CG	4692/-
	MB/PG	4950/-

SAP-174 (STICK ON PROFILE)		
<p>1 LENGTH: 3 MTR</p>	BLACK	1684/-
	RG/CG	1786/-
	MB/PG	1884/-

SAP-206 (STICK ON PROFILE)		
<p>1 LENGTH: 3 MTR</p>	BLACK	2125/-
	RG/CG	2253/-
	MB/PG	2377/-

SSH-001 (SLIDING HANDLE)		
<p>UNIT: PCS</p>	BLACK	1200/-
	RG/CG	1200/-
	MB/PG	1300/-

SPCA-172A		
	UNIT: PCS	280/-

SPCA-172		
	UNIT: PCS	400/-

SGP 1001		
	UNIT: PCS	500/-

SPCA-175		
	UNIT: PCS	130/-

REMOTE		
	UNIT: SET	3350/-

SSA-003		
	UNIT: SET	3350/-

SSA-027		
	UNIT: PCS	380/-



Available in Premium Finishes.

SWING DOOR



TRAVOS SWING DOOR

SAP-172 (HORIZONTAL)

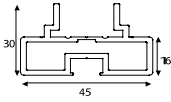

BLACK	5357/-
RG/CG	5678/-
MB/PG	5990/-

1 LENGTH: 3 MTR

SAP-173 (VERTICAL)

3000 4880

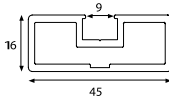

BLACK	4382/-	6906/-
RG/CG	4645/-	7321/-
MB/PG	4900/-	7723/-

1 LENGTH: 3 MTR

SAP-175 (DIVIDER)

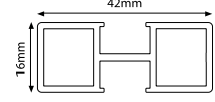

BLACK	4426/-
RG/CG	4692/-
MB/PG	4950/-

1 LENGTH: 3 MTR

SSPMH-001



BLACK	6380/-
RG/CG	6850/-
MB/PG	6850/-

SAP-174 (STICK ON PROFILE)

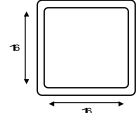

BLACK	1684/-
RG/CG	1786/-
MB/PG	1884/-

1 LENGTH: 3 MTR

SAP-206 (STICK ON PROFILE)

3000 4880

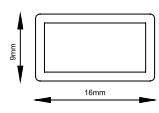

BLACK	2125/-	3265/-
RG/CG	2253/-	3461/-
MB/PG	2377/-	3651/-

SSPMH 003



BLACK	22,500/-
RG/CG	24,500/-
MB/PG	24,500/-

SPCA-172A



UNIT: PCS 280/-

SPCA-172



UNIT: PCS 400/-

SGP 1001



UNIT: PCS 500/-

SPCA-175



UNIT: PCS 130/-

SSL001 (SLIM PROFILE LOCK)



BLACK	8250/-
RG/CG	8750/-
MB/PG	9250/-

UNIT: PCS

ESILE SWING DOOR

SAP-202 (HORIZONTAL)

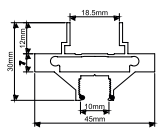

BLACK	6407/-
RG/CG	6791/-
MB/PG	7164/-

1 LENGTH: 3 MTR

SAP-201 (VERTICAL)

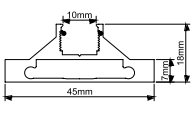

BLACK	5072/-
RG/CG	5377/-
MB/PG	5672/-

1 LENGTH: 3 MTR

SAP-215 (DIVIDER)

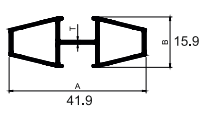

BLACK	2796/-
RG/CG	2964/-
MB/PG	3127/-

1 LENGTH: 3 MTR

SAP-216 (STICK ON PROFILE)

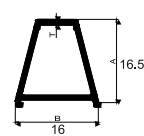

BLACK	1583/-
RG/CG	1678/-
MB/PG	1770/-

1 LENGTH: 3 MTR

SPCA-201



UNIT: PCS 220/-

SPCA-201A



UNIT: PCS 280/-

SGP 1002



UNIT: PCS 500/-

SSPMH-002



BLACK	6850/-
RG/CG	7850/-
MB/PG	7850/-

SSL002 (SLIM PROFILE LOCK)



BLACK	9075/-
RG/CG	9625/-
MB/PG	10,170/-

UNIT: PCS



Available in Premium Finishes.

CUBOID SWING DOOR

SAP-295 (HORIZONTAL)

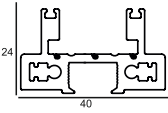

BLACK	6270/-
RG/CG	6646/-
MB/PG	7012/-

1 LENGTH: 3 MTR

SAP-294 (VERTICAL)

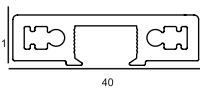

BLACK	4647/-
RG/CG	4926/-
MB/PG	5179/-

1 LENGTH: 3 MTR

SAP-296 (DIVIDER)

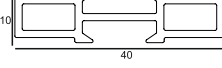

BLACK	3119/-
RG/CG	3306/-
MB/PG	3487/-

1 LENGTH: 3 MTR

SGP 1006



UNIT: PCS	500/-
-----------	-------

SPCA-298 (CONNECTOR)



UNIT: PCS	280/-
-----------	-------

SAP-206 (STICK ON PROFILE)

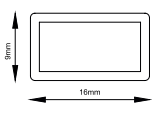

	3000	4880
BLACK	2125/-	3265/-
RG/CG	2253/-	3461/-
MB/PG	2377/-	3651/-

SSPMH-005



BLACK	6850/-
RG/CG	7850/-
MB/PG	7850/-

PRISM SWING DOOR

SAP-298 (HORIZONTAL)

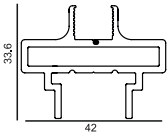

BLACK	5728/-
RG/CG	6071/-
MB/PG	6405/-

1 LENGTH: 3 MTR

SAP-297 (VERTICAL)

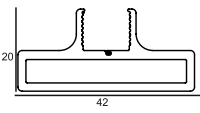

BLACK	4557/-
RG/CG	4830/-
MB/PG	5096/-

1 LENGTH: 3 MTR

SAP-299 (DIVIDER)

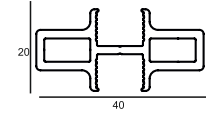

BLACK	4378/-
RG/CG	4641/-
MB/PG	4896/-

1 LENGTH: 3 MTR

SGP 1006



UNIT: PCS	500/-
-----------	-------

SPCA-298 (CONNECTOR)



UNIT: PCS	280/-
-----------	-------

SAP-206 (STICK ON PROFILE)

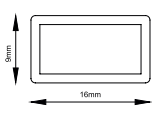

	3000	4880
BLACK	2125/-	3265/-
RG/CG	2253/-	3461/-
MB/PG	2377/-	3651/-

1 LENGTH: 3 MTR

SSPMH-004



BLACK	6850/-
RG/CG	7850/-
MB/PG	7850/-



MOCHA BROWN



CLASSIC GOLD



ROSE GOLD



CERAMIC BLACK



PORCELAIN GREY

Available in Premium Finishes.

SWING DOOR ACCESSORIES

SFS-1001 (80 KG EN-1-3)	
	SS 3754/-
	BL 4251/-
	CG/RG 4991/-
	MB/PG 5141/-

SFS-1002 (120 KG EN-1-2)	
	SS 7850/-
	BL 8350/-
	CG/RG 9350/-
	MB/PG 9550/-

SFS-1003 (120 KG EN-1-3)	
	SS 8186/-
	BL 8686/-
	CG/RG 9650/-
	MB/PG 9850/-

SFS-1004 (120 KG EN-1-4)	
	SS 8450/-
	BL 8950/-
	CG/RG 9950/-
	MB/PG 10150/-

SFS-1005 (120 KG EN-1-4)	
	SS 18900/-
	BL 19400/-
	CG/RG 20400/-
	MB/PG 20650/-

SDC-1103 (80 KG EN 1-3)	
	ALU 5150/-
	BL 5350/-
	CG/RG 7000/-
	MB/PG 7436/-

SDC-1105 (120 KG EN 1-4)	
	ALU 11650/-
	BL 12500/-
	CG/RG 13900/-
	MB/PG 14400/-

SDC-1103 ACP SHADDLE PLATE	
	BL 4857/-
	CG/RG 6007/-
	MB/PG 6500/-

SDC-1105 ACP SHADDLE PLATE	
	BL 4857/-
	CG/RG 6007/-
	MB/PG 6500/-

SGDH-001				
		SS	BL	CG/RG
	22X300	3170/-	3500/-	4040/-
	22X450	4260/-	4640/-	5410/-
	25X600	6070/-	6330/-	7480/-
	SET 25X750	7600/-	7920/-	8920/-

SGDH-002				
		SS	BL	CG/RG
	22X300	1900/-	2500/-	2830/-
	22X450	2460/-	2830/-	3250/-
	25X600	3530/-	4050/-	4450/-
	SET 25X750	4410/-	4950/-	5350/-

SGDH-003				
		SS	BL	CG/RG
	22X300	2050/-	2650/-	2850/-
	22X450	2597/-	3220/-	3550/-
	25X600	3880/-	4550/-	4850/-
	SET 25X750	4850/-	5500/-	5800/-

SGDH-004 (35X1500)	
	SS 15475/-
	BL 16900/-
	CG/RG 18900/-
	MB/PG 18900/-

SSH-003	
	BL 3000/-
	CG/RG 3200/-
	MB/PG 3350/-

SGT 001	
	
UNIT: PCS	644/-

SSA-006	
	
UNIT: SET	5150/-

SSA-031	
	
UNIT: SET	1800/-

SSA-010	
	
UNIT: PCS	1488/-



Available in Premium Finishes.

SWING DOOR ACCESSORIES

SSA-009H



BL	1350/-
CG/RG	1350/-
MB/PG	1350/-

SSA-035



BL	1045/-
CG/RG	1045/-
MB/PG	1045/-

SSA-011



BLACK	1800/-
RG/CG	2000/-
MB/PG	2000/-

SSL003



BLACK	6350/-
RG/CG	6750/-
MB/PG	6950/-

UNIT: PCS

SSL004



BLACK	31,550/-
RG/CG	31,550/-
MB/PG	31,550/-

UNIT: PCS

SPP-1055



BLACK	3400/-
RG/CG	3604/-
MB/PG	3802/-

1 LENGTH: 3 MTR

SAP-170

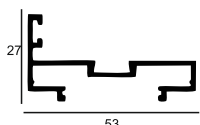

BLACK	3774/-
RG/CG	4000/-
MB/PG	4220/-

1 LENGTH: 3 MTR

SSA 005 (DOOR PIVOT)



UNIT: 1 SET	3050/-
-------------	--------

SAP-213/214

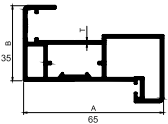

BLACK	7452/-
RG/CG	7899/-
MB/PG	8334/-

1 LENGTH: 3 MTR

SRS-103



UNIT: 1 MTR	38/-
-------------	------

SRS-101



UNIT: 1 MTR	42/-
-------------	------



Available in Premium Finishes.



SAP-401 (TOP/BOTTOM FRAME)

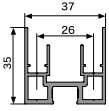

	3000	4880
BLACK	5749/-	9042/-
RG/CG	6439/-	10127/-
MB/PG	6954/-	10937/-

SAP-402 (VERTICAL)

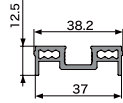

	3000	4880
BLACK	3501/-	5445/-
RG/CG	3921/-	6098/-
MB/PG	4235/-	6586/-

SAP-403 (COVER FOR VERTICAL)

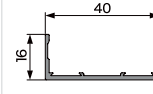

	3000	4880
BLACK	2449/-	3762/-
RG/CG	2743/-	4213/-
MB/PG	2963/-	4550/-

SAP-405 (DIVIDER)

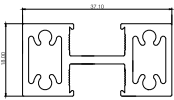

	3000	4880
BLACK	5482/-	8614/-
RG/CG	6140/-	9648/-
MB/PG	6631/-	10420/-

SGP 3001



UNIT: PCS 500/-

SSA-051 D

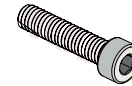

FRAME CONNECTING

UNIT: PCS 50/-

SFS-1001 (80 KG EN-1-3)



SS	3754/-
BL	4251/-
CG/RG	4991/-
MB/PG	5141/-

SFS-1002 (120 KG EN-1-2)



SS	7850/-
BL	8350/-
CG/RG	9350/-
MB/PG	9550/-

SFS-1003 (120 KG EN-1-3)



SS	
BL	8686/-
CG/RG	9650/-
MB/PG	9850/-

SFS-1004 (120 KG EN-1-4)



SS	8450/-
BL	8950/-
CG/RG	9950/-
MB/PG	10150/-

SFS-1005 (120 KG EN-1-4)



SS	18900/-
BL	19400/-
CG/RG	20400/-
MB/PG	20650/-

SSA-040 (100 KG OFF CENTER PIVOT)



UNIT: SET 49500/-

SSA-041 (100 KG CENTER PIVOT)



UNIT: SET 45000/-

SSA-042



UNIT: SET 7000/-



MOCHA BROWN



CLASSIC GOLD



ROSE GOLD



CERAMIC BLACK



PORCELAIN GREY

Available in Premium Finishes.



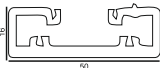

ORRA WASHROOM GLASS CUBICAL

SAP-301		2500	3800
	BLACK	4605/-	6965/-
	RG/CG	4881/-	7383/-
	MB/PG	5150/-	7789/-

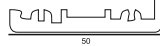
SAP-302		2500	3800
	BLACK	4185/-	6327/-
	RG/CG	4436/-	6706/-
	MB/PG	4680/-	7075/-

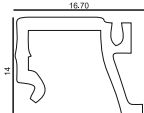
SAP-303		2500	3800
	BLACK	1361/-	2019/-
	RG/CG	1443/-	2140/-
	MB/PG	1522/-	2258/-

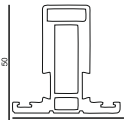
SAP-304		2500	3800
	BLACK	8783/-	13,331/-
	RG/CG	9310/-	14,131/-
	MB/PG	9822/-	14,908/-

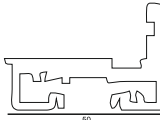
SAP-305		2500	3800
	BLACK	6587/-	9977/-
	RG/CG	6982/-	10,576/-
	MB/PG	7366/-	11,157/-

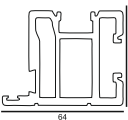
SAP-306		2500	3800
	BLACK	14,349/-	21,807/-
	RG/CG	15,210/-	23,116/-
	MB/PG	16,046/-	24,387/-

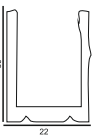
SAP-307		2500	3800
	BLACK	2799/-	4204/-
	RG/CG	2967/-	4457/-
	MB/PG	3130/-	4702/-

SAP-308		2500	3800
	BLACK	2705/-	4062/-
	RG/CG	2868/-	4305/-
	MB/PG	3025/-	4542/-

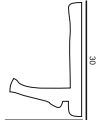
SAP-309		2500	3800
	BLACK	1905/-	2845/-
	RG/CG	2019/-	3016/-
	MB/PG	2130/-	3182/-

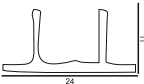
SAP-310		2500	3800
	BLACK	990/-	1435/-
	RG/CG	1050/-	1512/-
	MB/PG	1108/-	1605/-

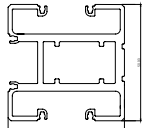
SAP-311		2500	3800
	BLACK	9832/-	14,933/-
	RG/CG	10,421/-	15,829/-
	MB/PG	10,995/-	16,700/-

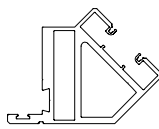
SAP-312		2500	3800
	BLACK	13,271/-	20,160/-
	RG/CG	14,067/-	21,370/-
	MB/PG	14,840/-	22,545/-



MOCHA BROWN



CLASSIC GOLD



ROSE GOLD



CERAMIC BLACK



PORCELAIN GREY

Available in Premium Finishes.

ORRA WASHROOM GLASS CUBICAL

SAP-313

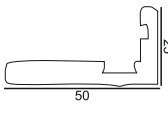

	2500	3800
BLACK	5527/-	8346/-
RG/CG	5859/-	8847/-
MB/PG	6181/-	9333/-

SAP-317

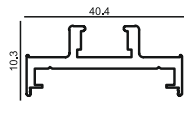

	3000
BLACK	4089/-
RG/CG	4334/-
MB/PG	4573/-

SAP-318

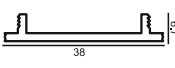

	3000
BLACK	2407/-
RG/CG	2552/-
MB/PG	2692/-

SRS-113
FOR 08MM GLASS



PER METER 90/-

SRS-114
FOR 10MM GLASS



PER METER 80/-

SRS-101



PER METER 42/-

SRS-103

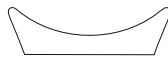

PER METER 38/-

SGP 1003



UNIT: 1 SET 500/-

SPCA-316



UNIT: PCS 280/-

SSA-036 (for 10mm glass)



UNIT: SET 2500/-

SSA-020



BLACK	3400/-
RG/CG	4000/-
MB/PG	4000/-

SSA-028



BLACK	4000/-
RG/CG	4440/-
MB/PG	4440/-

SSA-039



BLACK	4900/-
RG/CG	5150/-
MB/PG	5400/-

SSA-037



BLACK	3000/-
RG/CG	3250/-
MB/PG	3250/-

SSA-011



BLACK	1800/-
RG/CG	2000/-
MB/PG	2000/-

SSA-009H



BLACK	1350/-
RG/CG	1350/-
MB/PG	1350/-

SSA-005



UNIT: SET 3050/-

SSA-030



BLACK	3250/-
RG/CG	3450/-
MB/PG	3450/-



Available in Premium Finishes.



SAP-1101			
		3000	4880
	BLACK	4299/-	6808/-
	RG/CG	4557/-	7217/-
1 LENGTH: 3 MTR	MB/PG	4808/-	7614/-

SAP-1102			
		3000	4880
	BLACK	3479/-	5497/-
	RG/CG	3688/-	5820/-
1 LENGTH: 3 MTR	MB/PG	3891/-	6147/-

SAP-1103			
		3000	4880
	BLACK	1368/-	2119/-
	RG/CG	1450/-	2246/-
1 LENGTH: 3 MTR	MB/PG	1530/-	2369/-

SAP-1104			
		3000	
	BLACK	1615/-	
	RG/CG	1712/-	
1 LENGTH: 3 MTR	MB/PG	1806/-	

SAP-1105			
		3000	
	BLACK	1284/-	
	RG/CG	1361/-	
1 LENGTH: 3 MTR	MB/PG	1436/-	

SAP-1106			
		3000	4880
	BLACK	4562/-	7229/-
	RG/CG	4836/-	7663/-
1 LENGTH: 3 MTR	MB/PG	5102/-	8084/-

SPP-1046			
		3000	
	BLACK	2619/-	
	RG/CG	2776/-	
1 LENGTH: 3 MTR	MB/PG	2929/-	

SPP-1055			
		3000	
	BLACK	3400/-	
	RG/CG	3604/-	
1 LENGTH: 3 MTR	MB/PG	3802/-	

SRS-107 (for 8mm glass)	
PER METER	62/-

SRS-101	
PER METER	42/-

SRS-103	
PER METER	38/-

SRS-108(for 10mm glass)	
PER METER	55/-



MOCHA BROWN



CLASSIC GOLD



ROSE GOLD



CERAMIC BLACK



PORCELAIN GREY

Available in Premium Finishes.

SSA-028



BLACK	4000/-
RG/CG	4440/-
MB/PG	4440/-

SSA-036 (for 10mm glass)



UNIT: SET 2500/-

SSA-020



BLACK	3400/-
RG/CG	4000/-
MB/PG	4000/-

SSA-011



BLACK	1800/-
RG/CG	2000/-
MB/PG	2000/-

SSA-039



BLACK	4900/-
RG/CG	5150/-
MB/PG	5400/-

SSA-019



BLACK	2250/-
RG/CG	2550/-
MB/PG	2550/-

SSA-030



BLACK	3250/-
RG/CG	3450/-
MB/PG	3450/-

SSA-009H



BLACK	1350/-
RG/CG	1350/-
MB/PG	1350/-

SSA-005



UNIT: SET 3050/-

SAP-173 (VERTICAL)

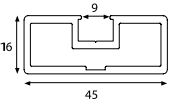

	3000	4880
BLACK	4382/-	6906/-
RG/CG	4645/-	7321/-
MB/PG	4900/-	7723/-

1 LENGTH: 3 MTR

SSA-032 CONCEALED MEGNET



UNIT: PCS 3050/-

SPCA-172A



UNIT: PCS 280/-

SPCA-172



UNIT: PCS 400/-

SGP 1001



UNIT: PCS 500/-





SAP-1116			
		2600	3800
	BLACK	7576/-	11,259/-
	RG/CG	8030/-	11,935/-
	MB/PG	8472/-	12,591/-

SAP-1115			
		2500	3800
	BLACK	6880/-	10,215/-
	RG/CG	7292/-	10,828/-
	MB/PG	7694/-	11,432/-

SAP-1118			
		2500	3800
	BLACK	3442/-	5137/-
	RG/CG	3648/-	5445/-
	MB/PG	3849/-	5745/-

SAP-1112			
		2500	3800
	BLACK	1926/-	2868/-
	RG/CG	2042/-	3040/-
	MB/PG	2154/-	3207/-

SAP-1117			
		2500	3800
	BLACK	1217/-	1832/-
	RG/CG	1290/-	1941/-
	MB/PG	1361/-	2048/-

SAP-1113			
		2500	3800
	BLACK	3406/-	5031/-
	RG/CG	3611/-	5333/-
	MB/PG	3809/-	5626/-

SAP-1108			
		2500	3800
	BLACK	2897/-	4341/-
	RG/CG	3071/-	4601/-
	MB/PG	3240/-	4854/-

SPP-1109			
		2500	3800
	BLACK	1417/-	2124/-
	RG/CG	1502/-	2252/-
	MB/PG	1585/-	2376/-

SPP-1110			
		2500	3800
	BLACK	3514/-	5242/-
	RG/CG	3725/-	5557/-
	MB/PG	3930/-	5862/-

SAP-319 (35/16 VERTICAL)			
	BLACK	4153/-	
	RG/CG	4402/-	
	MB/PG	4644/-	
1 LENGTH: 3 MTR			

SAP-320 (HORIZONTAL PROFILE)			
	BLACK	5271/-	
	RG/CG	5587/-	
	MB/PG	5894/-	
1 LENGTH: 3 MTR			

SAP-321 (DIVIDER PROFILE)			
	BLACK	4255/-	
	RG/CG	4511/-	
	MB/PG	4759/-	
1 LENGTH: 3 MTR			

SGP 1001	
UNIT: PCS	500/-

SPCA-319 (CONNECTOR)	
UNIT: PCS	280/-



REDDIK WASHROOM GLASS CUBICAL

SSA-028 (450x150)



BLACK	4000/-
RG/CG	4440/-
MB/PG	4440/-

SSA-036 (for 10mm glass)



UNIT: SET 2500/-

SSA-020 (450x150)



BLACK	3400/-
RG/CG	4000/-
MB/PG	4000/-

SSA-011



BLACK	1800/-
RG/CG	2000/-
MB/PG	2000/-

SSA-039



BLACK	4900/-
RG/CG	5150/-
MB/PG	5400/-

SSA-019



BLACK	2250/-
RG/CG	2550/-
MB/PG	2550/-

SSA-030



BLACK	3250/-
RG/CG	3450/-
MB/PG	3450/-

SSA-009H



BLACK	1350/-
RG/CG	1350/-
MB/PG	1350/-

SSA-005



UNIT: SET 3050/-

SSA-032 CONCEALED MEGNET



UNIT: PCS 3050/-

SRS-107 (for 8mm glass)



PER METER 62/-

SRS-108(for 10mm glass)



PER METER 55/-

SRS-101



PER METER 42/-

SRS-103



PER METER 38/-



Available in Premium Finishes.



ENTO WASHROOM GLASS CUBICAL

SAP-173 (VERTICAL)

		3100	4880
	BLACK	4382/-	6906/-
	RG/CG	4645/-	7321/-
1 LENGTH: 3 MTR	MB/PG	4900/-	7723/-

SAP-174 (STICK ON PROFILE)

	BLACK	1684/-
	RG/CG	1786/-
1 LENGTH: 3 MTR	MB/PG	1884/-

SAP-175 (DIVIDER)

	BLACK	4426/-
	RG/CG	4692/-
1 LENGTH: 3 MTR	MB/PG	4950/-

SAP-206 (STICK ON PROFILE)

		3000	4880
	BLACK	2125/-	3265/-
	RG/CG	2253/-	3461/-
1 LENGTH: 3 MTR	MB/PG	2377/-	3651/-

SAP-170

	BLACK	3774/-
	RG/CG	4000/-
	MB/PG	4220/-

SAP-208

	BLACK	3842/-
	RG/CG	4072/-
1 LENGTH: 3 MTR	MB/PG	4296/-

SGP 1001

UNIT: PCS	500/-
-----------	-------

SPCA-172A

UNIT: PCS	280/-
-----------	-------

SAP-227

	BLACK	6107/-
	RG/CG	6474/-
1 LENGTH: 3 MTR	MB/PG	6830/-



Available in Premium Finishes.

ENTO WASHROOM GLASS CUBICAL

SSA-028



BLACK	4000/-
RG/CG	4440/-
MB/PG	4440/-

SSA-036 (for 10mm glass)



UNIT: SET 2500/-

SSA-020



BLACK	3400/-
RG/CG	4000/-
MB/PG	4000/-

SSA-011



BLACK	1800/-
RG/CG	2000/-
MB/PG	2000/-

SSA-039

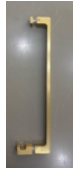

BLACK	4900/-
RG/CG	5150/-
MB/PG	5400/-

SSA-019



BLACK	2250/-
RG/CG	2550/-
MB/PG	2550/-

SSA-030



BLACK	3250/-
RG/CG	3450/-
MB/PG	3450/-

SSA-009A



BLACK	1350/-
RG/CG	1350/-
MB/PG	1350/-

SSA-005



UNIT: SET 3050/-

SSA-032 CONCEALED MEGNET



UNIT: PCS 3050/-

SRS-103



PER METER 42/-

SRS-103



PER METER 38/-

SSA-029



UNIT: PCS 260/-

SSA-015



UNIT: SET 1680/-



Available in Premium Finishes.



SLIM WASHROOM GLASS CUBICAL

SAP-188(12mm glass)

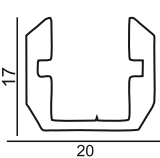

BLACK	2580/-
RG/CG	2760/-
MB/PG	2898/-

SAP-189(12mm glass)

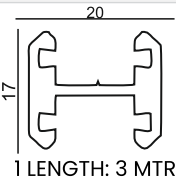

1 LENGTH: 3 MTR

BLACK	2580/-
RG/CG	2760/-
MB/PG	2898/-

SAP-188A(10mm glass)

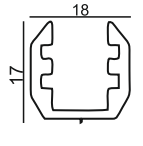

1 LENGTH: 3 MTR

BLACK	2458/-
RG/CG	2605/-
MB/PG	2748/-

SAP-189A(10mm glass)

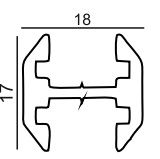

BLACK	2452/-
RG/CG	2599/-
MB/PG	2742/-

SAP-273(stick on)

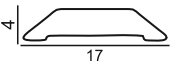

1 LENGTH: 3 MTR

BLACK	1376/-
RG/CG	1459/-
MB/PG	1539/-



Available in Premium Finishes.

SAP 101

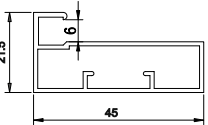

	3000
BLACK	3038/-
RG/CG	3220/-
MB/PG	3397/-
ALU	3038/-
SS	3220/-

1 LENGTH: 3 MTR

SAP 112

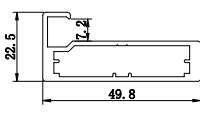

	3000
BLACK	4610/-
RG/CG	4886/-
MB/PG	5155/-
ALU	4610/-
SS	4886/-

1 LENGTH: 3 MTR

SAP 119

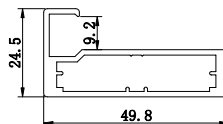

	3000
BLACK	4803/-
RG/CG	5091/-
MB/PG	5371/-
ALU	4803/-
SS	5091/-

1 LENGTH: 3 MTR

SAP 103

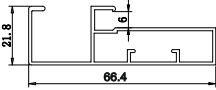

	3000
BLACK	3829/-
RG/CG	4059/-
MB/PG	4282/-
ALU	3829/-
SS	4059/-

1 LENGTH: 3 MTR

SAP 113

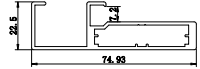

	3000
BLACK	5586/-
RG/CG	5922/-
MB/PG	6247/-
ALU	5586/-
SS	5922/-

1 LENGTH: 3 MTR

SAP 120

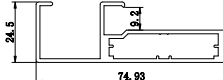

	3000
BLACK	5834/-
RG/CG	6184/-
MB/PG	6524/-
ALU	5834/-
SS	6184/-

1 LENGTH: 3 MTR

SAP 107

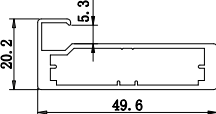

	3000
BLACK	4170/-
RG/CG	4420/-
MB/PG	4663/-
ALU	4170/-
SS	4420/-

1 LENGTH: 3 MTR

SAP 114

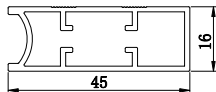

	3000
BLACK	3598/-
RG/CG	3814/-
MB/PG	4024/-
ALU	3598/-
SS	3814/-

1 LENGTH: 3 MTR

SAP 123

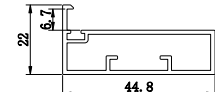

	3000
BLACK	3543/-
RG/CG	3755/-
MB/PG	3962/-
ALU	3543/-
SS	3755/-

1 LENGTH: 3 MTR

SAP 108

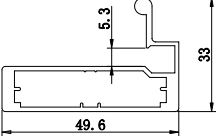

	3000
BLACK	4676/-
RG/CG	4957/-
MB/PG	5229/-
ALU	4676/-
SS	4957/-

1 LENGTH: 3 MTR

SAP 115

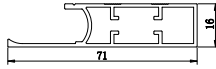

	3000
BLACK	4261/-
RG/CG	4517/-
MB/PG	4765/-
ALU	4261/-
SS	4517/-

1 LENGTH: 3 MTR

SAP 124

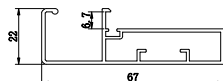

	3000
BLACK	4664/-
RG/CG	4944/-
MB/PG	5216/-
ALU	4664/-
SS	4944/-

1 LENGTH: 3 MTR



MOCHA BROWN



CLASSIC GOLD



ROSE GOLD



CERAMIC BLACK



PORCELAIN GREY

Available in Premium Finishes.

FRAME PROFILE

SAP 110

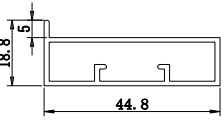

1 LENGTH: 3 MTR

	3000
BLACK	3490/-
RG/CG	3699/-
MB/PG	3903/-
ALU	3490/-
SS	3699/-

SAP 116

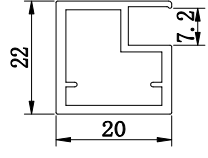

1 LENGTH: 3 MTR

	3000
BLACK	2729/-
RG/CG	2893/-
MB/PG	3052/-
ALU	2729/-
SS	2893/-

SAP 136

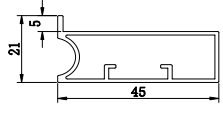

1 LENGTH: 3 MTR

	3000
BLACK	3314/-
RG/CG	3513/-
MB/PG	3706/-
ALU	3314/-
SS	3513/-

SAP 111

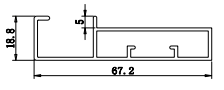

1 LENGTH: 3 MTR

	3000
BLACK	4442/-
RG/CG	4709/-
MB/PG	4968/-
ALU	4442/-
SS	4709/-

SAP 118

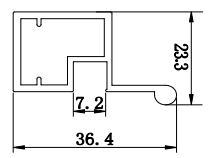

1 LENGTH: 3 MTR

	3000
BLACK	3308/-
RG/CG	3506/-
MB/PG	3699/-
ALU	3308/-
SS	3506/-

SAP 137

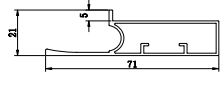

1 LENGTH: 3 MTR

	3000
BLACK	4284/-
RG/CG	4541/-
MB/PG	4791/-
ALU	4284/-
SS	4541/-

SAP 190

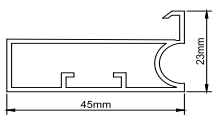

1 LENGTH: 3 MTR

	3000
BLACK	3850/-
RG/CG	4081/-
MB/PG	4306/-

SAP 191

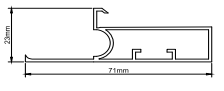

1 LENGTH: 3 MTR

	3000
BLACK	4821/-
RG/CG	5110/-
MB/PG	5391/-

SAP 117

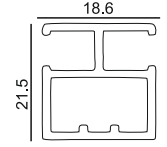

1 LENGTH: 3 MTR

	3000
BLACK	2476/-
RG/CG	2624/-
MB/PG	2769/-
ALU	2476/-
SS	2624/-



MOCHA BROWN



CLASSIC GOLD



ROSE GOLD



CERAMIC BLACK



PORCELAIN GREY

Available in Premium Finishes.

KITCHEN PROFILE

SAP 105

3000

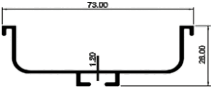

BLA / ALU	2936/-
RG/CG	3113/-
MB/PG	3284/-

1 LENGTH: 3 MTR

SAP 106

3000

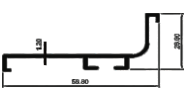

BLA / ALU	2467/-
RG/CG	2615/-
MB/PG	2759/-

1 LENGTH: 3 MTR

SAP 127

3000

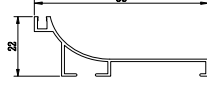

BLA / ALU	2826/-
RG/CG	2996/-
MB/PG	3160/-

1 LENGTH: 3 MTR

SAP 128

3000

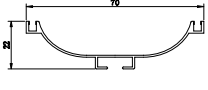

BLA / ALU	3310/-
RG/CG	3509/-
MB/PG	3702/-

1 LENGTH: 3 MTR

SAP 148

3000

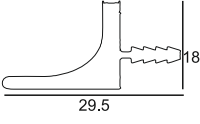

BLACK	3140/-
RG/CG	3329/-
MB/PG	3512/-

1 LENGTH: 3 MTR

SAP 149

3000

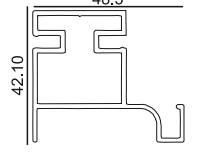

BLACK	4700/-
RG/CG	4982/-
MB/PG	5257/-

1 LENGTH: 3 MTR

SAP 150

3000

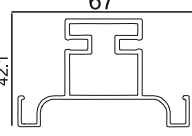

BLACK	5107/-
RG/CG	5413/-
MB/PG	5711/-

1 LENGTH: 3 MTR

SAP 271

3000

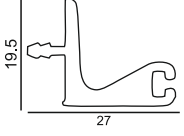

BLACK	2923/-
RG/CG	3098/-
MB/PG	3269/-

1 LENGTH: 3 MTR



MOCHA BROWN



CLASSIC GOLD



ROSE GOLD



CERAMIC BLACK



PORCELAIN GREY

Available in Premium Finishes.

KITCHEN HANDLE PROFILE

SAP 129

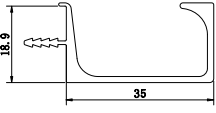

3000	
BLACK	2969/-
RG/CG	3147/-
MB/PG	3320/-
SS	3147/-

1 LENGTH: 3 MTR

SAP 131

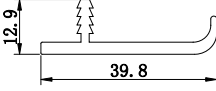

3000	
BLACK	3267/-
RG/CG	3463/-
MB/PG	3653/-
SS	3463/-

1 LENGTH: 3 MTR

SAP 132

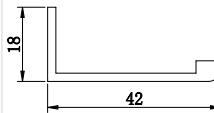

3000	
BLACK	2356/-
RG/CG	2498/-
MB/PG	2635/-
SS	2495/-

1 LENGTH: 3 MTR

SAP 169

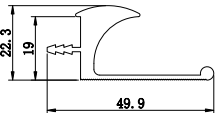

3000	
BLACK	3695/-
RG/CG	3916/-
MB/PG	4132/-

1 LENGTH: 3 MTR

SAP 266

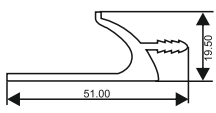

3000	
BLACK	3628/-
RG/CG	3846/-
MB/PG	4058/-

1 LENGTH: 3 MTR

SAP 270

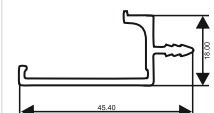

3000	
BLACK	2658/-
RG/CG	2817/-
MB/PG	2972/-

1 LENGTH: 3 MTR

SAP 272

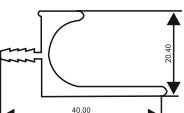

3000	
BLACK	3285/-
RG/CG	3482/-
MB/PG	3673/-

1 LENGTH: 3 MTR



MOCHA BROWN



CLASSIC GOLD



ROSE GOLD



CERAMIC BLACK



PORCELAIN GREY

Available in Premium Finishes.

SAP 134		SAP 135		SAP 151				
<p>1 LENGTH: 3 MTR</p>	3000	<p>1 LENGTH: 3 MTR</p>	3000	<p>1 LENGTH: 3 MTR</p>	3000			
	BLACK		1567/-		BLACK	1525/-	BLACK	1172/-
	RG/CG		1661/-		RG/CG	1617/-	RG/CG	1242/-
	MB/PG		1752/-		MB/PG	1705/-	MB/PG	1310/-
	SS		1661/-		SS	1617/-	SS	1242/-
SAP 152		SAP 154		SAP 155				
<p>1 LENGTH: 3 MTR</p>	3000	<p>1 LENGTH: 3 MTR</p>	3000	<p>1 LENGTH: 3 MTR</p>	3000			
	BLACK		1730/-		BLACK	1730/-	BLACK	1378/-
	RG/CG		1833/-		RG/CG	1833/-	RG/CG	1461/-
	MB/PG		1934/-		MB/PG	1934/-	MB/PG	1541/-
	SS		1833/-		SS	1833/-	SS	1461/-
SAP 156		SAP 157		SAP 162				
<p>1 LENGTH: 3 MTR</p>	3000	<p>1 LENGTH: 3 MTR</p>	3000	<p>1 LENGTH: 3 MTR</p>	3000			
	BLACK		1610/-		BLACK	1828/-	BLACK	1230/-
	RG/CG		1707/-		RG/CG	1938/-	RG/CG	1304/-
	MB/PG		1800/-		MB/PG	2044/-	MB/PG	1375/-
	SS		1707/-		SS	1938/-	SS	1304/-



MOCHA BROWN



CLASSIC GOLD



ROSE GOLD



CERAMIC BLACK



PORCELAIN GREY

Available in Premium Finishes.

GUJARAT DECOR PVT. LTD.

SURAT

8-9, Mahavir Small Industrial Estate,
Bamroli-Vadod Road,
Vadod Gam, Surat,
Gujarat. India - 394 221



CHANDIGARH

Nabha Sahib. Shop No 1.
Jagait Complex, High Ground Road,
Nabha Zirakpur Sas Nagar,
Chandigarh, Punjab - 140 603



PATNA

Ward No. 54Maurya Colony,
Behind Shiv Mandir,
East of BISCOMAN Colony,
PS Alanganj, Patna,
Bihar 800007



BENGALURU

225/1, Ground and 1st Floor,
4th Cross,
Lal Bagh Main Rd,
Bengaluru,
Karnataka 560027



Customer Care :  + 91 98989 90003

 hello@socarhardware.com

 www.socarhardware.com



facebook



website



instagram



youtube



catalogue

Legal Disclaimer

Whilst every effort has been made to ensure that the information contained in this brochure is accurate at the time of publication, SOCAR recommends that you consult SOCAR, its authorised distributors and dialers prior to placing an order to ascertain current information on specific product, as SOCAR reserves the right to make changes without prior notice. SOCAR will not be liable for any errors or omissions in the information contained in the brochure or arising from the use or application of the information contained herein. This brochure does not constitute an offer for the sale of any particular product.